

LCD TV

40 VLE 812 S

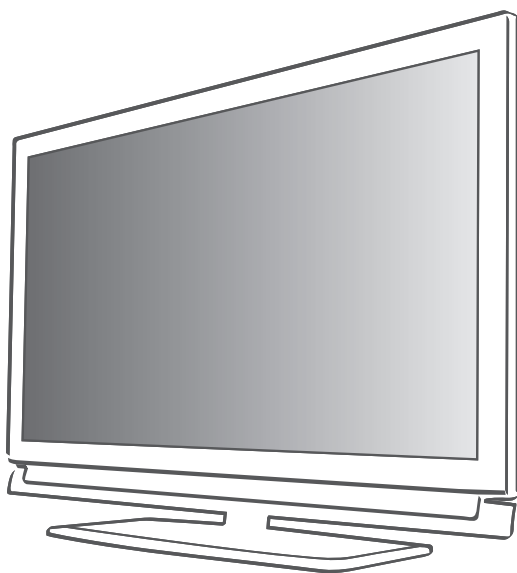

AUS GUTEM GRUND
GRUNDIG

CONTENTS

- 4 SETUP AND SAFETY**
- 6 GENERAL INFORMATION**
- 6 Special features of your television set
- 7 Receiving digital channels
- 7 Important notes on environmental protection
- 7 Notes on still images
- 8 CONNECTION AND PREPARATION**
- 8 Connecting the antenna and power cord
- 9 Inserting batteries into the remote control
- 10 OVERVIEW**
- 10 Connections on the television set
- 11 Controls on the television set
- 12 The remote control – Main functions
- 13 The remote control – All functions
- 14 SETTINGS**
- 14 Initial set-up and tuning television channels
- 14 Selecting language, country and operating mode
- 15 Tuning the television channels from satellite (DVB-S)
- 17 Tuning terrestrial television channels (DVB-T)
- 17 Tuning television channels from the cable provider (DVB-C)
- 18 Changing the program table for the digital channels
- 21 Picture settings
- 22 Sound settings
- 24 TELEVISION - OPERATION**
- 24 Basic functions
- 25 Zoom function
- 25 Eco mode
- 26 Zapping function
- 26 Electronic TV guide
- 27 Changing the picture format
- 28 3D FUNCTION**
- 28 Important information about the 3D function
- 28 Preparing the 3D function
- 29 3D Settings
- 31 SMART INTER@CTIVE TV AND HOME NETWORK**
- 31 What is Smart Inter@ctive TV
- 31 Network connection
- 31 Wired network
- 37 Smart Inter@ctive TV internet applications
- 39 Playback the video, music and image files with home network connection
- 40 vTuner internet radio
- 41 USB RECORDING**
- 41 Information on recording and playing television programmes
- 41 Possible limitations when using an external data medium
- 42 Connecting external data media
- 42 Settings for USB recording
- 44 "Pausing" time shift programmes
- 44 Recording programmes
- 45 Presetting programmes to be recorded
- 47 Playback
- 47 Deleting programmes in the recording list
- 48 USB OPERATION**
- 48 File formats
- 49 Connecting external data media
- 50 The file browser
- 50 Settings in the USB setup menu
- 51 Basic playback functions
- 52 Additional playback functions
- 54 TELETEXT OPERATION**
- 54 TOP text or FLOF text mode
- 54 Additional functions
- 55 INTERACTIVE PORTAL (HBBTV)**
- 55 What is HbbTV?
- 55 Additional functions for video sequences
- 56 CONVENIENCE FUNCTIONS**
- 56 Opening the SETTINGS menu
- 56 Language settings
- 57 Setting the date and time
- 57 Timer settings
- 58 Parental control settings
- 59 Updating software (OAD)
- 59 Updating software (Online)
- 59 Restoring the television to the default settings

CONTENTS

60 OPERATION USING EXTERNAL DEVICES

- 60 DIGI LINK
- 60 The DIGI LINK functions on your television
- 61 Device operation
- 62 High definition HD ready
- 62 Connection options
- 63 Connecting external devices
- 64 Using a DVD player, DVD recorder, video recorder or set-top box
- 64 Headphones
- 64 Hi-fi System

66 OPERATION AS A PC MONITOR

- 66 Connecting a PC
- 66 Selecting presets for the PC
- 66 Settings for PC mode

67 OPERATION WITH A COMMON INTERFACE

- 67 What is a Common Interface?
- 67 Inserting the CA module
- 67 Access control for CI module and smart card

68 SPECIAL SETTINGS

- 68 Searching for digital television channels from a satellite automatically
- 69 Searching for digital television channels from a satellite manually
- 69 LNB settings
- 70 Settings for motorised antennas (DiSEqC 1.2)
- 73 Searching for digital terrestrial TV channels automatically
- 74 Searching for digital terrestrial TV channels manually
- 75 Tuning analogue television channels
- 76 Changing stored analogue channels

78 INFORMATION

- 78 Displaying signal information
- 79 Technical data
- 80 Service information for dealers
- 80 Environmental note
- 81 Troubleshooting
- 83 Additional Information for units sold in the UK.

SETUP AND SAFETY

Please note the following instructions when setting up the television set:

- This television is designed to receive and display video and audio signals. All other uses are expressly prohibited.
- The ideal viewing distance is five times the diagonal screen size.
- Light falling on the screen impairs picture quality.
- To ensure the device is always adequately ventilated, make sure there is sufficient space between the television set and nearby furniture.
- The television is designed for use in dry rooms. If you do use it outdoors, make sure it is protected from moisture such as rain or splashing water. Never expose the television set to moisture.
- Do not place any vessels such as vases on the television, as they may spill liquid, thus presenting a safety risk.
- Place the television on a hard, level surface.
- Do not place any objects such as newspapers on the television or put cloth or similar items under it.
- Do not place the television close to heating units or in direct sunlight, as this will impair cooling.
- Heat build-up can be dangerous and shortens the service life of the television. For reasons of safety, have a repairman remove any dirt in the television from time to time.
- Never open the television under any circumstances. Warranty claims are excluded for damage resulting from improper handling.
- Make sure the power cord or the power supply unit (if provided) are not damaged.
- Only operate the television with the power supply/power cord provided.
- Thunderstorms are a danger to all electrical devices. Even when the television is switched off, it can be damaged by a lightning strike to the mains or the antenna. Always disconnect the mains and antenna plugs during a storm.
- Use a damp, soft cloth to clean the screen. Do not use water with soap or detergent.
- Only clean the housing of your television set with the cloth provided. Do not use water with soap or detergent.
- When deciding where to put the device, remember that furniture is often coated with various types of varnish and plastic. Many of these contain chemicals which can corrode the feet of the device, leaving marks on the surface of the furniture which can be difficult or impossible to remove.
- The screen of your LCD/LED television meets the highest quality standards and has been checked for pixel faults. Despite the great care taken in manufacturing, technological reasons make it impossible to completely discount the possibility that some pixels may be faulty. Provided they are within the thresholds specified by the DIN norm, pixel faults of this kind cannot be regarded as a defect as defined by the warranty.
- To ensure fires do not occur, always keep candles and other open flames away from the device.

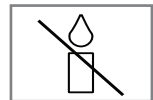

SETUP AND SAFETY

- Do not connect any other equipment while the device is switched on. Also switch off other equipment before connecting it.
- Do not plug in the power cord of the device until you have connected the external equipment and the antenna.
- Make sure the mains plug is freely accessible.
- Do not expose the batteries to excessive heat such as direct sunlight, fire, etc.
- Do not use old and unused batteries together.
- Only replace the exhausted batteries with those having the same model, value and properties.
- By ensuring proper disposal of these batteries, you will have contributed in prevention of potential hazards on the environment and human health that may arise from inappropriate disposal of the batteries.

Caution:

- If you plan on using a wall bracket for your television, make sure you read the assembly manual for the wall bracket or have a specialist assemble it.
- When purchasing the wall bracket, make sure that all the fastening points on the television are also on the wall bracket and that they are all used when mounting it.

GENERAL INFORMATION

Special features of your television set

- You can receive and watch digital TV channels using your television set (via DVB-S, DVB-T and DVB-C) – including High Definition programmes (HD). However, the reception of digital TV channels in HD is currently limited to a few countries in Europe.
- Although this television set complies with the current DVB-S, DVB-T and DVB-C standards (status: August 2010), the compatibility with future DVB-S satellite transmissions as well as terrestrial DVB-T and DVB-C cable programmes cannot be guaranteed.
- Your television set can receive and process all analogue and non-encrypted digital TV channels. The television set is also equipped with digital and analogue receivers.
- The electronic TV guide (for digital channels only) informs you about any schedule changes at short notice, and provides an overview of all the broadcasters' schedules for the next few days. Detailed information on the individual television programmes are – when provided by the broadcasting station – are also available in the electronic TV guide.
- You can connect various data media, such as an external hard drive, a USB memory stick or a digital camera, to the USB socket. Using the file browser, you can then select and play the file formats of your choice (for example, MP4, MP3 or JPEG data).
- Using the time shift function, you can quickly and easily pause a programme using the remote control and resume it at a later stage. The programme is recorded in an external data medium.
- You can record any digital TV channels you choose.

The TV channels are converted by the television and saved on an external data medium which is connected to the USB socket. The saved programmes can be called up and played from the archive on the external data medium at any time.

You can also play a programme from the archive while recording another. More information on recording and playing TV programmes can be found from page 41.
- Your Grundig television and 3D shutter glasses can provide the reality of the cinema when you watch 3D movies in your home. This TV uses state-of-the-art LED technology to give you the best experience 3D has to offer. To join the 3D world, you just need to put on the Grundig 3D glasses.
- Smart Inter@ctive TV feature provides your TV with the Internet services and pages when it is connected to the Internet. You can visit popular video and photo sharing sites as well as social networks. And you can watch TV and listen to radio on web.
- DLNA feature allows you to use a wired or wireless local network to access your content that were recorded with DLNA compatible devices we use at our daily lives such as a PC, mobile phone or NAS (Network Attached Storage) which are operated as DMS (Digital Media Server). Thanks to DMR feature, when DLNA application has been started, you can automatically start and stop media playing on devices with DMC feature.
- Devices that contain and serve video, music or image files are called Server. This television receives video, music and image files from the server through home network, allowing you to access and play such media even when your television is located in a different room than the server. A DLNA compatible device such as a PC, mobile phone, NAS or a NAS-like (Network attached storage) device which operates as a DMS (Digital Media Server) is required in order to use home network.

GENERAL INFORMATION

Receiving digital channels

- You require a satellite antenna to receive digital satellite channels (DVB-S).

Your TV supports SCR system (Satellite Channel Router). If your antenna installation is equipped with an Single Cable Distribution multiswitch, all television sets which are connected on this antenna can receive the television channels stand-alone.

- You require a digital roof antenna or indoor antenna (passive or active indoor antenna with its own power supply) to receive digital television channels (DVB-T).
- If you wish to receive digital television channels via your cable system (DVB-C), the antenna cable for your cable operator must be connected to the television set.
- Unlike analogue broadcasting, not every channel has its own transmission frequency. Instead, several channels are grouped into what are known as bouquets on a regional or national level. You can find the current transmission information on teletext from various broadcasters, or by consulting a current TV guide or the Internet.
- Various digital television channels from private broadcasters are encrypted (DVB-S, DVB-T and DVB-C). Watching these channels and the recording and playback functions are only possible with the appropriate CI module and a SmartCard. Ask your specialist dealer. The range of channels available from the public broadcasting institutions (ARD with EinsExtra, EinsFestival or ZDF with ZDF Info and all third party broadcasters) are not encrypted and can be received without a SmartCard.

Important notes on environmental protection

- The following information will help you to save resources – and money as well.
- If you are not using your television set for several days, you should pull out the mains plug for environmental and safety reasons. This way the television does not consume any electricity.

- As switching off the television set does not completely disconnect it from the mains, pull out the plug to disconnect it from the mains completely.
- If the device is equipped with a power switch, switching it off using this switch will be sufficient. The energy consumed by the television set is reduced to virtually 0 W.
- In standby mode, the television set uses very little energy. However, it may be necessary to leave the television set in standby mode for certain functions (for example automatic switch-on and switch-off and for timer functions).
- The television set uses less energy when the brightness is reduced.

Notes on still images

Watching the same image for a long time on the screen may cause a still image remains feebly on the background. Feeble image(s) on the background is originated from LCD/LED technology and does not require any action under guarantee. To avoid such cases and/or minimize the impact, you may observe the tips below.

- Do not allow the same TV channel to stay on the screen for a very long time. Channel logos may cause this situation.
- Do not allow the images, which are not full screen, to constantly stay on the screen; if not streamed in full screen format by the broadcaster, you can convert the images to full screen by changing picture formats.
- Higher brightness and/or contrast values will lead this impact to appear faster; therefore, you are recommended to watch your TV in the lowest brightness and contrast levels.

CONNECTION AND PREPARATION

Connecting the antenna and power cord

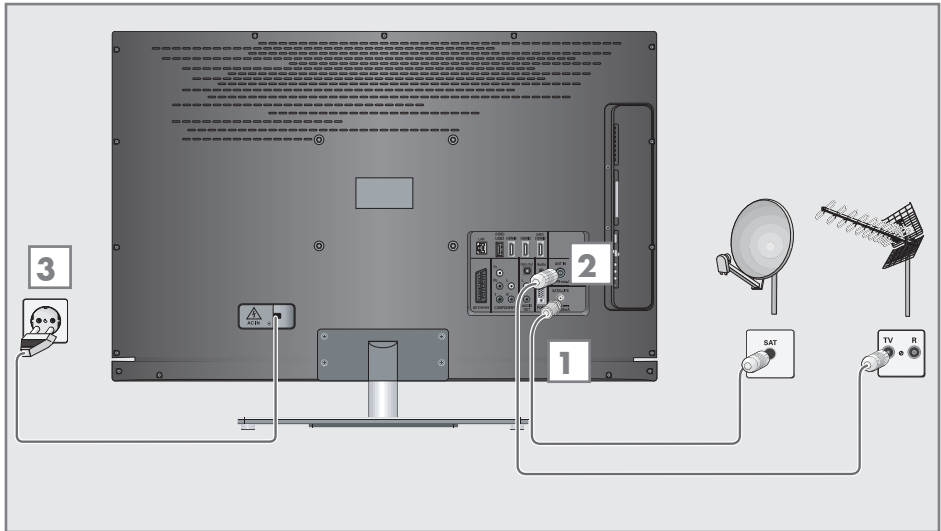

- 1** To receive digital satellite channels (DVB-S), connect the satellite antenna cable to the antenna socket »**SATELLITE**« on the television set.

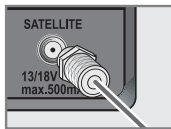

And/or:

- 2a** To receive terrestrial digital broadcasters (DVB-T) connect the cable for the rooftop or indoor antenna (passive or active indoor antenna with its own power supply) to the antenna socket »**ANT IN**« on the television set;
or
- 2b** To receive digital cable channels (DVB-C) connect the cable for the rooftop antenna to the antenna socket »**ANT IN**« on the television set;
or
- 2c** To receive analogue TV channels, connect the cable for the rooftop antenna to the antenna socket »**ANT IN**« on the television set

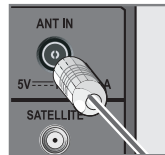

Note:

- When connecting an indoor antenna you may have to try it out at different positions until you get the best reception.

- 3** Plug the power cord into a wall socket.

Note:

- Do not plug in the power cord of the device until you have connected the external equipment and the antenna.
- Only use the power cord supplied to connect the television set to a suitable earthed safety socket.
- Do not use an adapter plug or extension lead which does not meet the applicable safety standards. Do not tamper with the power cord.

CONNECTION AND PREPARATION _____

Inserting batteries into the remote control

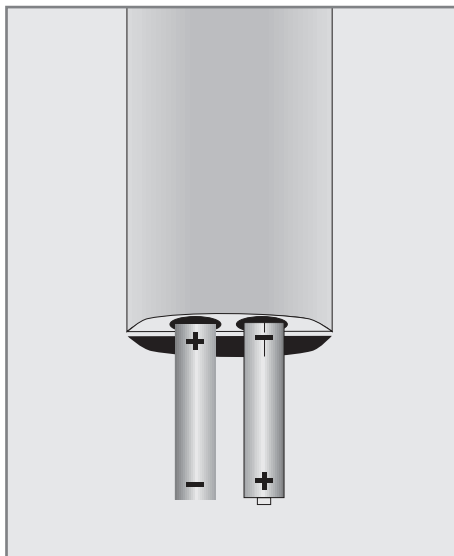

- 1 Open the battery compartment by removing the lid.
- 2 Insert the batteries (2 x 1.5 V micro, for example R03 or AAA). Observe the polarity marked in the bottom of the battery compartment.
- 3 Close the battery compartment.

Note:

- If the television no longer reacts properly to remote control commands, the batteries may be flat. Always remove used batteries.
- The manufacturer accepts no liability for damage caused by leaking batteries.

Environmental note



This symbol on rechargeable batteries/batteries or on the packaging indicates that the rechargeable battery/battery may not be disposed of with regular household rubbish. For certain rechargeable batteries/batteries, this symbol may be supplemented by a chemical symbol. Symbols for mercury (Hg) or lead (Pb) are provided if the rechargeable batteries/batteries contain more than 0.0005% mercury or more than 0.004% lead.

Rechargeable batteries/batteries, including those which do not contain heavy metal, may not be disposed of with household waste. Always dispose of used batteries in accordance with local environmental regulations. Make enquiries about the applicable disposal regulations where you live.

OVERVIEW

Connections on the television set

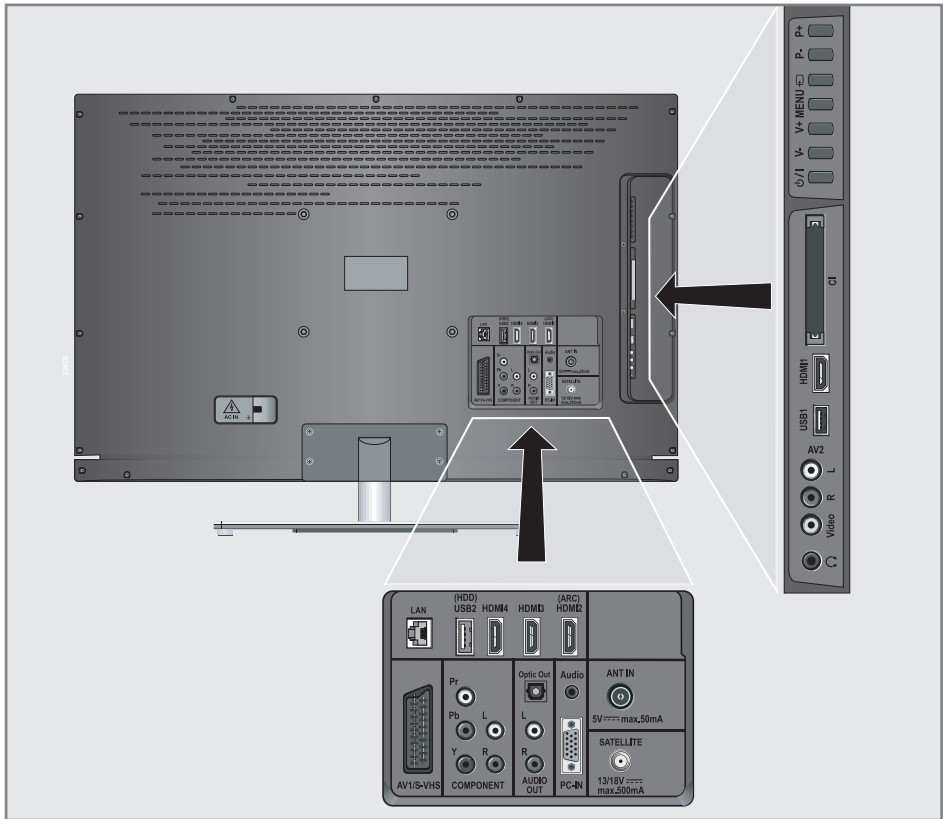

- AC IN** Socket for the mains cable.
- AV1 / S-VHS** SCART socket (CVBS signal, RGB signal); Video and sound socket for S-Video camcorder.
- COMPONENT Y Pb Pr** Sockets for video input (YUV signal).
- L R** Sockets for audio input (YUV signal).
- Optic Out** Socket for audio output (optical) for PCM/AC3 signals. For connecting digital AV amplifiers or AV receivers.
- AUDIO OUT L R** Sockets for audio output.
- Audio** Socket for audio input for a PC.
- PC-IN** VGA socket, video input for PC.
- SATELLITE** Antenna socket for the satellite antenna (DVB-S).
- ANT IN** Antenna socket for a DVB-T, DVB-C and analogue antenna.

OVERVIEW

HDMI2 (ARC)	HDMI socket, audio/video input.
HDMI3	HDMI socket, audio/video input.
HDMI4	HDMI socket, audio/video input.
USB2 (HDD)	USB socket for external data media and PVR function.
LAN	Network cable connection socket.
	Headphone jack (3.5 mm jack plug); Sockets for audio output.
AV2	
Video	Video socket for camcorder
L R	Audio socket for camcorder.
USB1	USB socket for external data media without a power supply of their own and PVR function.
HDMI1	HDMI socket, audio/video input.
CI	Common Interface Slot.

Controls on the television set

	Switches the television on and back into standby mode.
V- V+	Adjusts the volume; selects menu functions.
MENU	Opens the menu. Select a menu option with »P+« or »P-«. Activate the function with »V+«. Confirm the function with »V+« or »V-«.. Press »MENU« to quit the menu.
SOURCE	Opens the pre-selection for AV channels. In the menu, press »P+« or »P-« to select and press »SOURCE« to confirm.
P- P+	Switches the television on from standby; selects channels in steps; selects function in the menu.

OVERVIEW

The remote control – Main functions

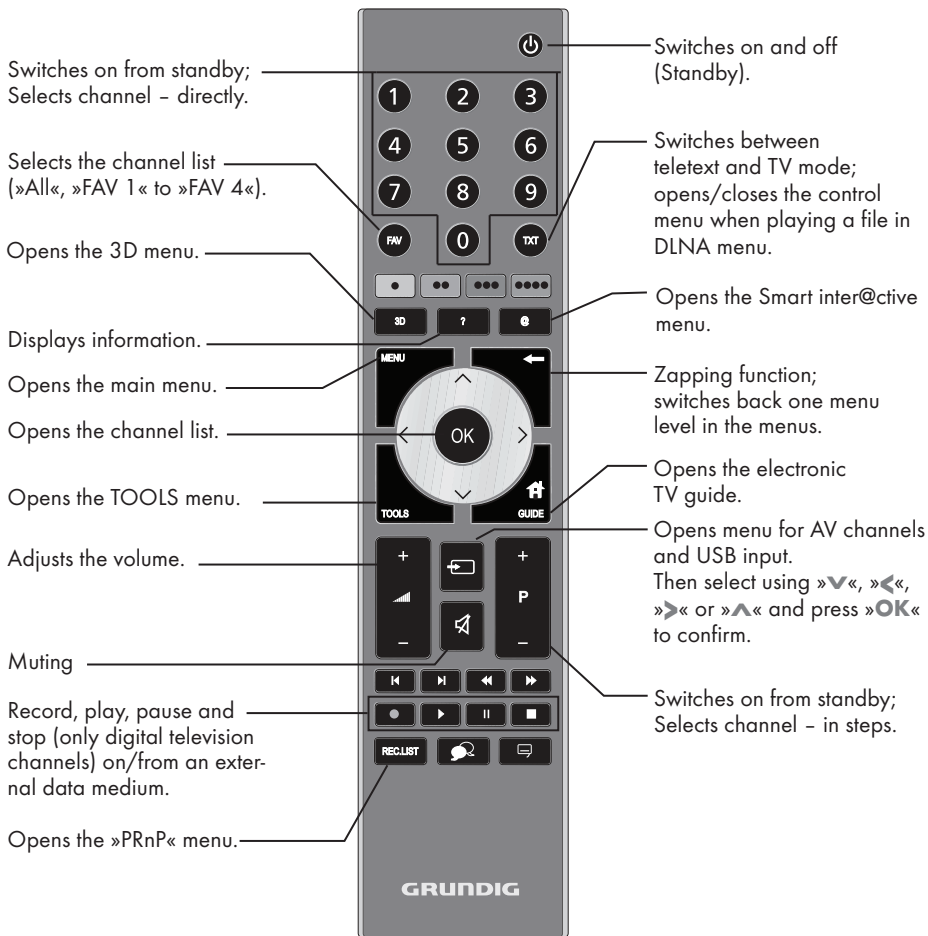

Navigation in the menus



Moves the cursor up
and down in the menus.

Moves the cursor to the left and
right in the menus.

Activates various functions and
save functions/settings.

OVERVIEW

The remote control – All functions

- @ Opens the Smart inter@ctive menu.
- (red) Selects pages in teletext;
- (green) Selects/activates various functions in the menus.
- (yellow)
- (blue)
- ◀ Selects different audio settings;
Switches to double character size in teletext;
Selects the next title/next picture in the file browser.
- ▶ Selects different picture settings;
Refreshes a teletext page;
Selects the previous track/previous picture in the file browser.
- ◀◀ Stops scrolling through pages in teletext;
Starts a fast reverse search in the file browser.
- ▶▶ Selects the channel list (»All«, »FAV 1« to »FAV 4«);
Reveals answers in teletext;
Starts a fast forward search in the file browser.
- Starts the recording (only for digital television channels, the recording is made on an external data medium).
- ▶ Starts playing a programme from an external data medium;
Repeats a recorded programme;
Starts playing in DLNA and vTuner menu.
- || Freeze frame, if no external data medium is connected;
Playback pause;
Time shift mode (only for digital television channels and when an external data medium is connected);
Pauses the file being played in DLNA and vTuner menu.



Ends playback of a programme from an external data medium;
Ends a recording or playback in time shift mode;
Splits the screen in teletext;
Ends playing in DLNA and vTuner menu.



Selects different audio languages (only for digital television channels)



Selects different subtitles (only for digital television channels)

Note:

- Your TV supports remote control feature for Apple iPhones and Android phones. Depending on the features of your TV, you may control your TV by your phone after downloading the free »GRUNDIG TV Remote« application from Apple App Store or Android Market and install it on the Apple iPhone/Android phone.

Initial set-up and tuning television channels

The television set is equipped with automatic channel search, which searches for satellite channels (DVB-S), terrestrial channels (DVB-T), cable channels (DVB-C) and analogue channels.

You start the search and the television channels will be stored into the Program Table. Following, you can sort the television channels in the Program Table.

For DVB-S channels there are 6000 presets available, for DVB-T and DVB-C channels 1000 presets, and 99 presets for analogue channels.

The various settings

Depending on the type of antenna connected, you can decide which channels you would like the television to search for.

- Tunes digital television channels from the satellite, from page 15.

You have two options for this search:

- the basic installation which presets a standard selection, e.g. the satellite Astra 19.2° East; you need only start the search;
- the professional installation, which allows you to make all required settings and set parameters for your receiver system.

- Tunes digital terrestrial television channels, on page 17.

- Tunes digital television channels from the cable provider, on page 17.

- Tunes analogue television channels, in the chapter "Special functions", starting on page 75.

- Further settings for digital television channels after the initial set-up can also be found in the chapter "Special Settings", starting on page 68.

Note:

- Make the language and country selection for all types, then continue reading the respective chapter.

Selecting language, country and operating mode

- 1 Switch on the television set from standby with »**⏻**«, »**1...0**« or »**P+**« or »**P-**«.
 - During initial set-up, the »Installation Guide« will be displayed.

Help:

- If this menu is not displayed, restore the television set to its default settings (see page 59).
- 2 Select the menu language with »**◀**«, »**▶**«, »**▼**« or »**▲**« and press »**OK**« to confirm.
 - 3 Select the mode with »**◀**« or »**▶**« and press »**OK**« to confirm.
 - The settings used in »Home Mode« help to save energy.
 - Alternatively, the menu item »Shop Mode« can be selected which the retailer can use for demonstrating the device functions.

Note:

- End the »Shop Mode« by restoring the television set to its default settings (see page 59).
- 4 Select the country in which the television set is operated with »**◀**«, »**▶**«, »**▼**« or »**▲**« and press »**OK**« to confirm.
 - The »Source Setup« menu appears with the »Connection Type« line marked.

Note:

- You can find a description of how to tune the television channel of your choice - depending on the antenna connected - in the following chapters.

Tuning the television channels from satellite (DVB-S)

You have two options for tuning digital satellite channels.

- A** The easy installation, which pre-configures all antenna settings for the satellite channels on Astra 19.2° East.
- B** The advanced installation can be used if you wish to receive satellite channels from various satellites. To do so, you must make the antenna settings (Satellite, LNB Power, LNB Type, DISEqC Mode, LNB Selection) for the satellites chosen.

Easy installation

- 1** In the »Source Setup« menu, in the »Connection Type« line, select the option »Satellite« with »◀« or »▶«.
- 2** Select the line »Easy Installation« with »▼« or »▲« and press »OK« to confirm.
 - Other menu options will be displayed, the satellite Astra 19.2° East is preset.
- 3** Start the scan with »♦♦♦« (green).
 - The »Search results« menu appears, and the scan for TV channels begins.
 - Depending on the number of television channels received, this can easily take a few minutes.
 - The scan is complete as soon as the »PROGRAM TABLE« appears.

Note:

- You can abort the scan by pressing »MENU«.

Advanced installation

- 1** In the »Source Setup« menu, in the »Connection Type« line, select the option »Satellite« with »◀« or »▶«.
- 2** Select the line »Advanced Installation« with »▼« or »▲« and press »OK« to confirm.
 - The menu appears.



- 3** Select the line »Satellite« with »▼« or »▲« and press »OK« to confirm.
 - The »SELECT SATELLITE« menu appears. Select the satellites with »▼«, »▲«, »◀« or »▶« and press »OK« to confirm.

Note:

- The setting in the line »Transponder« is not required for this automatic scan.
- 4** Select the line »LNB Power« with »▼« or »▲«.
Depending on the type of LNB, set the LNB power supply to »13/18 V« or »14/19 V« with »◀« or »▶«.
 - 5** Select the line »LNB Type« with »▼« or »▲«.
Select the type of LNB installed with »◀« or »▶«.

SETTINGS

- Select the line »DiSEqC Mode« with »▼« or »▲«. Select »DiSEqC 1.0« or »DiSEqC 1.1« in accordance with the existing antenna system with »◀« or »▶«.
 - DiSEqC 1.0 allows up to four satellites to be received simultaneously.
 - DiSEqC 1.1 allows up to 16 satellites to be received simultaneously.
- Select the line »LNB Selection« with »▼« or »▲«. Select the setting for the respective satellites with »◀« or »▶«.
- Once the settings for the satellite have been made, switch to the »AUTOMATIC CHANNEL SEARCH« menu with »•« (red).

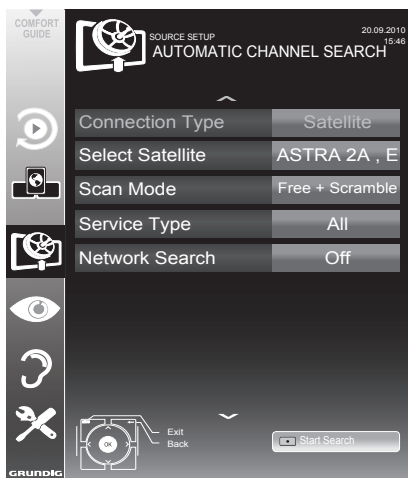

- Select the line »Scan Mode« with »▼« or »▲«. Select the scan mode with »◀« or »▶« (for unencrypted channels, for encrypted channels only, or for both).
- Select the line »Service Type« with »▼« or »▲«. Use »◀« or »▶« to select whether you want to search for television channels only (TV), radio stations only (Radio) or both (Radio + TV).

- Start the scan with »•« (red).
 - The »Results« menu appears, and the scan for TV channels begins.
 - Depending on the number of television channels received, this can easily take a few minutes.
 - The scan is complete as soon as the »PROGRAM TABLE« appears.

Note:

- You can abort the scan by pressing »MENU«.

- Press »MENU« to end the setting.

Note:

- If other television channels are to be tuned from a second satellite, proceed as follows:

Open the menu with »MENU«, select the line »SOURCE SETUP« with »▼« or »▲« and press »OK« to confirm. Then select the »Automatic Channel Search« with »▼« or »▲« and press »OK« to confirm. Confirm the line »Select Satellite« with »OK« and select the preferred satellite with »▼«, »▲«, »◀« or »▶«. Start the scan with »•« (red). Continue the adjustment by step 7 of the chapter.

Note:

- Before recording HD channels, please check signal quality and Strength, see chapter "Displaying signal information" on page 78. If the level is displayed in green, you can record HD channels without any problems.

Tuning terrestrial television channels (DVB-T)

- 1 In the »Source Setup« menu, in the »Connection Type« line, select the option »Air« with »◀« or »▶«.
- 2 Select the line »Scan Type« with »▼« or »▲«.
Use »◀« or »▶« to set the required scan type:
 - »DTV«, scan for digital television channels;
 - »ATV«, scan for analogue television channels;
 - »DTV & ATV«, scan for analogue and digital television channels.

Caution:

- The antenna power supply (5V ---) may only be switched on if the antenna is an active indoor antenna with a signal amplifier and it is not already supplied with a voltage via a mains plug (or similar supply). Otherwise you may cause a short circuit and irreparably damage your antenna.
- 3 Select the line »Active Antenna Power« with »▼« or »▲«.
Switch on the antenna power supply for the antenna with »◀« or »▶« (»On«).
 - 4 Start the scan with »***« (green).
 - The »Search Results« menu appears, and the search for TV channels begins.
 - Depending on the number of television channels received, this can easily take a few minutes.
 - The scan is complete as soon as the »PROGRAM TABLE« appears.

Note:

- You can abort the scan by pressing »MENU«.
- 5 Press »MENU« to end the setting.

Note:

- Before recording HD channels, please check signal quality and Strength, see chapter "Displaying signal information" on page 78. If the level is displayed in green, you can record HD channels without any problems.

Tuning television channels from the cable provider (DVB-C)

- 1 In the »Source Setup« menu, in the »Connection Type« line, select the option »Cable« with »◀« or »▶«.
- 2 Select the line »Scan Type« with »▼« or »▲«.
Use »◀« or »▶« to set the required scan type:
 - »DTV«, scan for digital television channels;
 - »ATV«, scan for analogue television channels;
 - »DTV & ATV«, scan for analogue and digital television channels.
- 3 Select the line »Cabel Scan Type« with »▼« or »▲«. Select the preferred option (»Quick« or »Full«) with »◀« or »▶«.
 - The search function »Quick« sets up the channels according to the information provided by your cable provider in the transmission signal.
 - If the option »Full« is selected, the entire frequency range will be scanned. The search can take a long time with this option. This option is recommended if your cable provider does not support the scan type »Quick«.

Note:

- You can accelerate the search. To do this, you need information about the frequency and network ID. You are usually able to get this data from your cable operator or find it in forums on the Internet.
- 4 Start the scan with »***« (green).
 - The »Search Results« menu appears, and the search for TV channels begins.
 - Depending on the number of television channels received, this can easily take a few minutes.
 - The scan is complete as soon as the »PROGRAM TABLE« appears.

Note:

- You can abort the scan by pressing »MENU«.
- 5 Press »MENU« to end the setting.

Note:

- Before recording HD channels, please check signal quality and Strength, see chapter "Displaying signal information" on page 78. If the level is displayed in green, you can record HD channels without any problems.

SETTINGS

Changing the program table for the digital channels

Channels which are found using the scan are saved in the »PROGRAM TABLE«.

You can delete channels which are not required from the programme table, you can change the order of channels within the programme table and lock individual channels (Parental control).

You can also add channels to the favourites list; in addition, you can change the order of channels within the favourites list.

With »♦♦« (green) you can display the channels which belong to one network.

Switch to the next page in the programme table with »P+« and to the previous page with »P-«.

With »♦♦♦« (yellow) you can open the »LIST MANAGEMENT« within the programme table. In this List Management you can create your own favourites lists.

With »♦♦♦♦« (blue) you can sort the channels according different criteria.

Selecting channel lists

- 1 Open the menu with »MENU«.
- 2 Select the »SOURCE SETUP« menu with »▼« or »▲« and press »OK« to confirm.
– The »SOURCE SETUP« menu appears.
- 3 Select the line »Programme Table« with »▼« or »▲« and press »OK« to confirm.
– The menu »PROGRAM TABLE« appears.

Important:

- Programme table and favourites lists are saved separately according to the different input sources (satellite, cable, air).
- When opening the programme table, the respective channel list for the current input signal appears.

Note:

- If in the Program Table **CA** appears added to the name of the channel, you need a CI module and a Smart-Card for watching these channels.



SETTINGS

Deleting channels

- 1 In the »PROGRAM TABLE« menu, select the Edit mode by pressing »*« (red).
- 2 Select the television channel to be deleted with »V«, »^«, »<« or »>« and press »♦♦♦« (yellow) to delete.

Note:

- You can delete all channels with »♦♦♦« (blue).
- 3 Confirm the deletion process with »♦« (green);
or
cancel the deletion process with »*« (red);
 - 4 Quit the program table with »MENU«.

Change the order of the channels in the program table

- 1 In the »PROGRAM TABLE« menu, select the Edit mode by pressing »*« (red).
- 2 Select the channel which should be moved with »V«, »^«, »<« or »>« and mark it with »*« (red).
- 3 Move the channel to its new position with »V«, »^«, »<« or »>« and press »OK« to confirm.

Note:

- Repeat steps 2 and 3 if you would like to change other channels.
- 4 Quit the program table with »MENU«.

Sorting channels in the program table

You can sort the order of the channels in the program table according different criteria: in order of Satellite, alphabetical or in order of encrypted/free channels.

- 1 In the »PROGRAM TABLE« menu, select the Sort mode by pressing »♦♦♦« (blue).
- 2 Select the sort criteria with »*« (red), »♦« (green) or »♦♦♦« (yellow).
- 3 Quit the program table with »MENU«.

Skipping channels

You can mark television channels which should be skipped when selecting with »^« or »V«. It is still possible to select them using the number buttons.

- 1 In the »PROGRAM TABLE« menu, switch over to the list view with »♦♦♦« (yellow).
- 2 Select the preferred channel with »V« or »^«.
- 3 Select the column »Skip« with »<« or »>« and use »OK« to mark the channel.
- The channel is marked by »V«.
- 4 Quit the program table with »MENU«.

Note:

- Channels can also be reactivated. Select the channel with »V« or »^«, then select the column »Skip« and reactivate the channel with »OK«.

Creating lists of favourites

You can save your favourite channels in up to four favourites lists (FAV 1 to FAV 4).

Notes:

- Favourites lists must be created separately for all input sources (satellite, cable, air).
 - You can select the favourites list by pressing »FAV«.
- 1 In the »PROGRAM TABLE« menu, switch over to the list view with »♦♦♦« (yellow).
 - 2 Select the channel of your choice with »V« or »^«.
 - 3 "Push" the channel into the favourites lists 1 to 4 with »<« or »>« and press »OK« to confirm.
- The position in the favourites list is marked with »V«.
- You can enter the same channel in more than one favourite list.
- Each favourite list can store up to 255 channels.

Note:

- Channels can also be deleted from the favourites lists. Select the channel to be deleted with »V«, »^«, »<« or »>« and press »OK« to delete it.
- When deleting a channel from the favourites list, the order within the favourites list will be updated.

- 4 Quit the program table with »MENU«.

Sorting channels in the favourite list

You can change the order of channels in the favourites list.

- 1 In the »PROGRAM TABLE« menu, select the favourites list »1« to »4«.
- 2 Select the channel which should be moved with »V«, »^«, »<« or »>« and mark it with »*« (red).
- 3 Move the channel to its new position with »V«, »^«, »<« or »>« and press »OK« to confirm.

Notes:

- Repeat steps 2 and 3 if you would like to change other channels within the same favourites list.
 - Repeat steps 1 to 3 if you would like to change channels in a different favourites list.
- 4 Exit the current favourites list with »....« (blue).
 - The entire programme table will appear again.
 - 5 Quit the program table with »MENU«.

Enter own names for the favourites lists (max. 6 characters)

You can enter own names for all favourites lists.

- 1 In the »PROGRAM TABLE« menu, switch over to the list view with »...« (yellow).
- 2 Select the desired favourites list with »1« till »4«.
 - The Favorite Name screen is displayed.
- 3 Delete the „old“ name (FAV1), for this purpose select with »V«, »^«, »<« and »>« the push button »X« and delete the character with »OK«.
- 4 Select the required character/numeric with »V«, »^«, »<« and »>« and confirm with »OK«.

Repeat the procedure for further characters/ numerics.

 - Select »ABC« for uppercase and »abc« for lower case and confirm with »OK«.
 - Select »?@123« for numbers and symbols and confirm with »OK«.
- 5 Confirm the new name, select the push button »Submit« with »V«, »^«, »<« or »>« and confirm with »OK«.
- 6 Press »MENU« to end the setting.

Picture settings

- 1 Open the menu with **»MENU«**.
- 2 Select the menu item **»PICTURE SETTINGS«** with **»▼«** or **»▲«** and press **»OK«** to confirm.
 - The **»PICTURE SETTINGS«** menu appears.

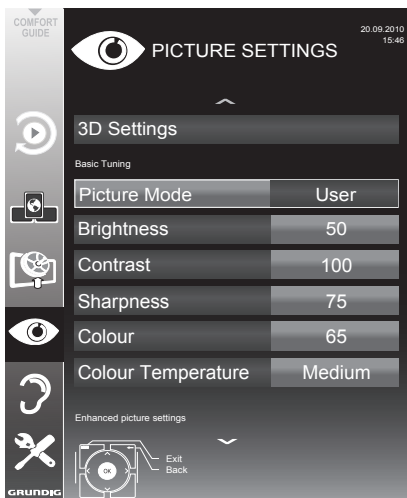

- 3 Select the line **»Picture Mode«**, **»Brightness«**, **»Contrast«**, **»Sharpness«**, **»Colour«**, or **»Colour Temperature«** with **»▼«** or **»▲«**. Select the value with **»◀«** or **»▶«** and press **»OK«** to confirm.

Notes:

- When changing the values with **»◀«** or **»▶«**, the screen will be split. You can see the current picture value on the left side, the new setting on the right side. This feature is not supported in 3D mode
 - In the **»PICTURE SETTINGS«** menu you can also find other additional settings.
- 4 Select the line **»DNR«**, **»Mpeg NR«**, **»Vibrant Colour«**, **»Perfect Clear«**, **»Film Mode«**, **»Gamma«**, **»Dynamic Contrast«**, **»Dynamic Backlight«**, **»Backlight«** or **»MEMC«** with **»▼«** or **»▲«**. Select the value with **»◀«** or **»▶«** and press **»OK«** to confirm.

Notes:

- You can only select the **»Mpeg NR«** function on digital and AV presets.
 - »Mpeg NR« reduces any interference from artefacts (pixel blocks) from digital programmes due to MPEG compression (such as from DVB-T receivers or DVD players).
 - The **»Film Mode«** detects and processes feature films automatically for all channel sources. This means you will always receive an optimal picture.
 - This functions in the modi 480i, 576i and 1080i in TV playback and for other channel sources.
 - If the **»Film mode«** is switched on for programmes without a feature film signal, minor problems such as picture freeze, defective subtitles or fine lines in the picture could occur.
 - The function **»Dynamic Contrast«** adapts the contrast dynamically and optimally for the respective picture content.
 - With **»Dynamic Backlight«**, the device optimally adapts the background lighting to the picture content.
 - The **»Backlight«** can only be set manually when the function **»Dynamic Backlight«** is deactivated.
 - **»MEMC«** will only appear in menus of LCD products with 200 Hz PPR Feature and LED products with 400 Hz PPR feature..
- 5 Press **»MENU«** to end the setting.

Sound settings

- 1 Open the menu with »MENU«.
- 2 Select the menu item »SOUND SETTINGS« with »▼« or »▲« and press »OK« to confirm.
 - The »SOUND SETTINGS« menu appears.



Note:

- Additional operations are explained in the following sections.

Volume

- 1 Select the line »Volume« with »▼« or »▲« and change the setting with »◀« or »▶«.

Balance

- 1 Select the line »Balance« with »▼« or »▲« and change the setting with »◀« or »▶«.

Automatic volume

Television stations broadcast at different volumes. The automatic volume limiting (AVL) function means the volume is kept the same when you switch between channels.

- 1 Select the line »AVL« with »▼« or »▲« and select the option »On« with »◀« or »▶«.

Note:

- If the »SRS TS HD« setting has been selected in the »Audio Mode« line, the AVL line cannot be selected.

Stereo/two channel sound, mono

If the device receives two-channel-sound programmes, e.g. a film with the original soundtrack on audio channel B (display: »Dual II«) and the dubbed version on sound channel A (display: »Dual I«), you can select the audio channel you prefer.

If the device receives stereo or Nicam programmes, it switches automatically to stereo sound (display: »Stereo«).

You can switch the sound to »Mono« if the stereo sound quality is poor.

- 1 Select the line »Audio Type« with »▼« or »▲« and adjust the setting with »◀« or »▶«.

Stereo width

This broadens the sound output for stereo programmes and improves the sound with mono reception.

- 1 Select the line »Audio Mode« with »▼« or »▲«.
- 2 Select the option »Spatial« with »◀« or »▶«.

SETTINGS

Soundeffects

This menu offers three preset sound effects (Music, Natural and Speech) and one setting to be created by you (User).

- 1 Select the line »Sound Preset« with »▼« or »▲«.
- 2 Select the sound effect »Music«, »Natural« or »Speech« by pressing »◀« or »▶«.

Note:

- »User« option is active when »Sound mode« setting is selected as »Normal« or »Spatial«.

SRS TruSurround HD

SRS TruSurround HD is a patented audio technology which is integrated into the television set and only requires the built-in speakers to generate a Surround Sound effect.

- 1 Select the line »Sound Mode« with »▼« or »▲«.
- 2 Select the option »SRS TS HD« with »◀« or »▶«.
- 3 Select the line »SRS Sound Preset« with »▼« or »▲«.
- 4 Select the sound effect »Music«, »Natural« or »Speech« with »◀« or »▶«.

Equalizer

Equalizer offers a sound setting "User" that you can create.

Equaliser appears in the menu when »Sound mode« is selected as »Spatial« or »Normal«, and »Sound Medium« as »User«.

- 1 Select »Equalizer« with »▼« or »▲« and press »OK« to confirm.
The »EQUALIZER« menu appears.

Note:

- If the »SRS TS HD« setting has been selected in the »Sound Mode« line, the »Equalizer« line will not indicate.
- 2 Select the frequency bandwidth »120Hz« with »▼« or »▲«.
Set the preferred value with »◀« or »▶«.
 - 3 Set the next frequency bandwidth with »▼« or »▲« and repeat the setting.
 - 4 Press »◀« to save the setting.

Audio description (Audio subtitles)

Audio description is an additional audio channel for visually-impaired persons. Descriptions are provided of activities, surroundings, changes of scene, gestures and actors' facial expressions.

This audio channel is transmitted simultaneously with the normal sound on digital channels. Availability depends on the respective channel and broadcaster.

- 1 Select the line »Audio Description« with »▼« or »▲« and select the option »On« with »◀« or »▶«.
- 2 Select the line »Volume« with »▼« or »▲« and change the volume with »◀« or »▶«.

Exiting the setting

- 1 Press »MENU« to end the setting.

* Under licence from SRS Labs, Inc. TruSurround HD, SRS and the  symbol are trademarks of SRS Labs, Inc.

Basic functions

Switching on and off

- 1 Press »**I O**« on the device, to switch the television in standby mode.
- 2 Press »**⏻**«, »**1...0**« or »**P+**« or »**P-**« to switch on the television from standby mode.
- 3 Press »**⏻**« to switch the television to standby.

Selecting channels

- 1 Press »**1...0**« to select presets directly.
- 2 Select channels step by step with »**P+**« or »**P-**«.
- 3 Open the channel list with »**OK**«, select the preferred television channel with »**▼**«, »**▲**«, »**◀**« or »**▶**« and press »**OK**« to confirm. Exit the channel list with »**MENU**«.

Selecting channels from lists

You can select channels from various lists (e.g. all channels, FAV 1 to FAV 4).

- 1 Press »**FAV**« to open an overview of programme tables.
– The overview is displayed.
- 2 Select a channel list with »**▲**« or »**▼**« and open it with »**OK**«.
- 3 Select a television channel with »**▼**«, »**▲**«, »**◀**« or »**▶**« and press »**OK**« to confirm.
- 4 Press »**MENU**« to exit the channel list.

Selecting a preset AV channel

- 1 Open the »Select Source« menu with »**⏪**«.
- 2 Select an AV preset with »**▼**«, »**▲**«, »**◀**« or »**▶**« and press »**OK**« to confirm.
- 3 Use »**1...0**« to switch back to the television channel.

Adjusting the volume

- 1 Adjust the volume with »**+ 🔊 -**«.

Switching sound on/off

- 1 Press »**🔇**« to mute the sound or switch it on again.

Displaying information

- 1 Display information, press »**?**« repeatedly.
– The display disappears automatically after a short while.

Freeze-frame

If you wish to view a particular scene for longer, you can "freeze" the frame of the current programme.

- 1 Activate the freeze-frame function with »**⏮**«.
- 2 End the freeze-frame function with »**⏮**«.

Note:

- If an external data medium is connected to the television, the time shift function is activated with »**⏮**«. The time shift function is described on page 44.

Picture settings

Various picture settings are available.

- 1 Open the Tools menu with »**TOOLS**«.
- 2 Select the menu item »Picture Mode« with »**▼**« or »**▲**«.
- 3 Select »User«, »Eco TV«, »Vivid«, »Natural«, »Movie«, »Sports« or »Game« by pressing »**◀**« or »**▶**«.
– You can change the »User« picture setting; see "Picture settings" on page 21.

Note:

- Picture setting »Game« can only be selected in »HDMI«, »Component« and »PC« modes.

Audio settings

Various audio settings are available.

- 1 Open the Tools menu with »**TOOLS**«.
- 2 Select the menu item »Sound Preset« with »**V**« or »**A**«.
- 3 Select the audio setting »User«, »Music«, »Natural« or »Speech« by pressing »**◀**« or »**▶**«.
 - You can change the »User« audio setting
 - see the "Soundeffects" chapter on page 23.

Note:

- »User« option is active when »Sound mode« setting is selected as »Normal« or »Spatial«.

Audio language

Various languages are available on digital television channels. This depends on the programme being broadcast.

- 1 Open the selection menu with »«.
- 2 Select the language by pressing »**V**« or »**A**« and press »**OK**« to confirm.

Subtitles

Various subtitles are available on digital television channels. This depends on the programme being broadcast.

- 1 Open the selection menu with »«.
- 2 Select the subtitles with »**V**« or »**A**« and press »**OK**« to confirm.

Note:

- Subtitles in terrestrial digital broadcasts are not supported in 3D mode.

Zoom function

This function allows you to enlarge the picture as required.

- 1 Open the Tools menu with »**TOOLS**«.
- 2 Select the menu item »Zoom« with »**V**« or »**A**«.
- 3 Press »**OK**« repeatedly to enlarge the display in three steps.

Note:

- Zoom feature is not supported in 3D mode.

Eco mode

This function allows you to reduce the power consumption.

- 1 Open the Tools menu with »**TOOLS**«.
- 2 Select the menu item »Eco TV« with »**V**« or »**A**«.
- 3 Switch on the Eco mode with »**◀**« or »**▶**«.
- 4 Switch the Eco mode off again with »**◀**« or »**▶**«.

Zapping function

This function remembers the channel you are currently watching while you switch over to other ones (zapping).

- 1 Press »**1...0**« or »**P+**«, »**P-**« to select the channel to be stored in the zapping memory and press »**←**« to confirm.
- 2 Press »**1...0**« or »**▲**«, »**▼**« to switch to another television channel.
- 3 Press »**←**« to switch between the saved television channel and the last television channel viewed.
- 4 End the function with »**MENU**«.

Electronic TV guide

The electronic TV guide provides an overview of all programmes that will be broadcast in the next week (for digital channels only).

- 1 Press »**GUIDE**« to display channel information.

Notes:

- Not all channels supply provide a detailed TV guide.
- Many broadcasters transmit the current schedule, but do not offer detailed descriptions.
- There are broadcasters which do not provide any information at all.

- 2 Press »**▼**« or »**▲**« to select a television channel.
 - Today's programmes on the television channel selected are displayed.
- 3 Switch to the information about the current programme with »**►**«.

Notes:

- You can open and switch off the extensive programme information with »**?**«.
- You can add the selected broadcast to the memory timer by pressing »**OK**«.

- 4 Press »**▼**« to select information on the next programme and, »**▲**« to return to the information for the current programme.
- 5 Select programmes on over the coming days with »**•••**« (green), and switch back to the current day with »**••**« (red).
- 6 Switch back to the channel selection with »**◀**«.

Note:

- Filter for certain programmes with »**•••••**« (blue), select the channel type with »**◀**«, »**►**«, »**▼**« or »**▲**« and press »**OK**« to confirm. Programmes which match the selected channel type are displayed.

- 7 Quit the electronic TV guide with »**MENU**«.

Changing the picture format

The television automatically switches to the 16:9 format if this format is detected via the SCART socket.

- 1 Open the Tools menu with **»TOOLS«**.
- 2 Select the menu item **»Picture Format«** with **»V«** or **»^«** and press **»OK«** to confirm.
- 3 Select the picture format with **»<«** or **»>«** and press **»OK«** to confirm.
 - You can choose between the following picture formats:

»Auto« format

The picture format is automatically switched to **»16:9«** for 16:9 programmes.

The picture format is automatically switched to **»4:3«** for 4:3 programmes.

»16:9« and »14:9« formats

For programmes in 4:3 format, the picture is stretched horizontally if the **»16:9«** format or **»14:9«** format is selected.

The picture geometry is stretched horizontally.

With actual 16:9 input sources (from a set-top box on the SCART socket) the picture fills the screen completely and with the correct geometry.

»4:3« format

The picture is shown in 4:3 format.

»LetterBox« format

The letterbox format is especially suitable for programmes in 16:9 format.

The black borders which are usually at the top and bottom of the screen are eliminated, 4:3 pictures fill the screen.

The transmitted pictures are enlarged, but are slightly cropped at the top and bottom. The picture geometry remains unchanged.

»Subtitle« format

If you cannot see the subtitles at the bottom of the screen, select **»Subtitle«**.

»Panorama« format

This setting is suitable for films in an especially wide format.

During programmes in 4:3 format, the picture is stretched horizontally if the **»Panorama«** function is selected. The picture geometry is stretched horizontally.

»Overscan off« format

In this mode, HD pictures are not cropped by the HDMI sockets or component sockets, and are displayed in their original size. This only applies in HDMI mode and for resolutions of 720p or above.

Note:

- Picture format selection is not supported in 3D mode.

3D FUNCTION

Important information about the 3D function

- Keep a sufficient distance from the television. The optimum distance is three times the height of the screen. Watching 3D films from a close distance for a long time could impair your vision.
- Never use the 3D function for longer than 3 hours without a break.
- It is essential that you supervise children watching a 3D programme to prevent damage to their health. Children under 6 years should not watch 3D content because their spatial vision is not yet completely developed.
- Watching 3D movies with 3D shutter glasses for long durations may cause headaches or fatigue. Stop watching if you get a headache, feel dizzy or generally unwell.
- Do not use the 3D function if you are anxious, sleepy or overtired.
- If you or a member of your family suffers with epilepsy, you should consult your doctor before watching 3D films.
- If, when watching a 3D film, your vision becomes impaired, you feel dizzy or nauseous, your eyes hurt, you have muscle spasms or have difficulty in concentrating, you must stop watching immediately.
- 3D images can startle the viewer. We recommend that elderly persons, pregnant women and persons with serious physical complaints avoid watching 3D content.
- Do not use the 3D glasses for other purposes, for example as sunglasses or protective glasses, as this may impair your sight.

Preparing the 3D function

Your Grundig television and 3D shutter glasses can provide the reality of the cinema when you watch 3D movies in your home.

This TV uses state-of-the-art LED technology to give you the best experience 3D has to offer.

To join 3D world, you just need to put on the Grundig 3D glasses.

Notes:

- Only use the GRUNDIG AS-3D G glasses. Do not use 3D glasses from other manufacturers.
- Grundig AS-3D G glasses are also sold separately. Please contact your dealer.
- The infrared transmitter is located at the lower left corner of the television and emits the signals at 90° horizontally and 40° vertically.
- It may not be possible to obtain 3D effects when there is an obstacle between the infrared transmitter and the glasses.

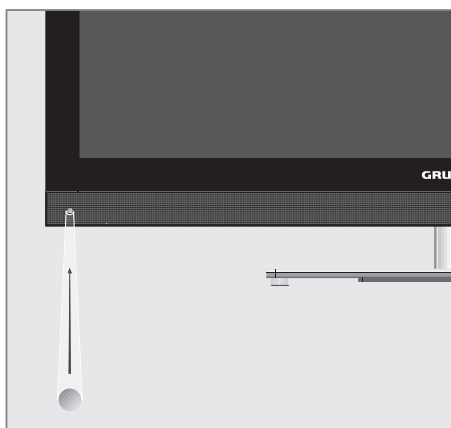







3D FUNCTION

Watching 3D films

Notes:



- The 3D function is supported using the »DVB-T«, »DVB-C«, »DVB-S« and »DLNA« channel sources or external devices connected to the »HDMI«, »YPbPr«, »VGA« or »USB« inputs.
- With »HDMI«, »YPbPr« and »VGA« inputs, 3D mode is only possible with resolutions at »1280 x 720p 50/60 Hz«, »1920 x 1080i 50/60 Hz« and »1920 x 1080p 24/30, 50/60 Hz«.
- The 3D experience depends on the format and features of the movie (resolution, sharpness etc.) being played.
- If 3D mode is activated for a picture which is not in 3D, the picture on the screen may appear blurry both with or without the 3D glasses.
- The 3D effect may degrade if you watch 3D images under fluorescent light. In such cases, either reduce the light or turn off the lamp.
- Your TV will switch from 3D mode to 2D mode for the following: if the program table or EPG information is displayed, the channel or the source are changed, playback of a 3D film is completed or the next film starts to play in USB or PVR mode.

- 1 Open the »Select Source« menu with »«.
- 2 Select the source (digital channel or suitable input) that will be played in 3D with », », », »« and confirm with »OK«.
- 3 Open 3D menu with »3D« button and use », »« button to select »Side by Side«, »Top Bottom« or »2D → 3D« option according to the content to be played and confirm with »OK«.
 - »2D → 3D«: Changes 2D picture to 3D.
 - »Side by Side«: Displays a picture next to the other one.
 - »Top Bottom«: Displays a picture below the other one.
 - »Frame Packing«: Right and left images of the TV are displayed alternately.

Note:

- Frame Packing appears in the 3D menu only if a video signal is sent to the »HDMI« input in HDMI 1.4 format. The »Side by Side« and »Top Bottom« options do not appear.
- 4 Turn off the 3D function by setting it to »Off« with »3D« and confirm with »OK«.

3D Settings

- 1 Open the menu with »MENU«.
- 2 Select the line »PICTURE SETTINGS« with », »« and confirm with »OK«.
 - The »PICTURE SETTINGS« menu appears.
- 3 Select »3D SETTINGS« with »« and confirm with »OK«.
 - The »3D SETTINGS« menu is displayed.

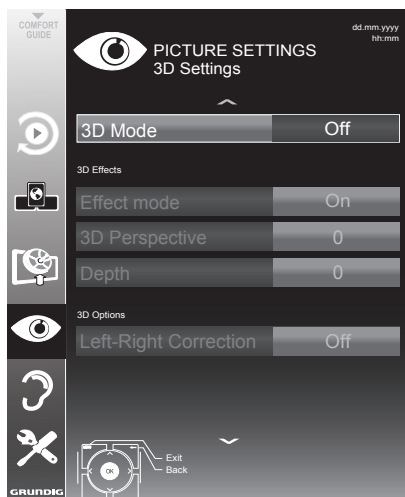

Note:

- Additional operations are explained in the following sections.

3D FUNCTION

Adjusting 2D → 3D effects

When you change 2D broadcasting to 3D, you can adjust the most suitable effect depending on your personal preferences.

- 1 Select »Effect mode« with »▼« or »▲« and set it to »On« with »◀« or »▶«.
– »3D Perspective« and »Depth« options are activated.
- 2 Select »3D Perspective« with »▼« or »▲« and adjust with »◀« or »▶«.
- 3 Select »Depth« with »▼« or »▲« and select the picture setting as »Low«, »Medium« or »High« with »◀« or »▶«.
- 4 Press »MENU« to end the setting.

Left - Right Correction

When Frame Packing mode is enabled in HDMI source, 3D perception may disappear in 3D films or 3D games due to a synchronization shift arising from HDMI signal. You may correct 3D perception with this feature.

- 1 Select »Left-Right Correction« with »▼« or »▲«.
- 2 Press »◀« or »▶« to switch the function »On«.

Note:

- Set the function to »Off« with »◀« or »▶«.

- 3 Press »MENU« to end the setting.

Formats supported by HDMI 1.4

With HDMI 1.4, your TV can recognise and play 3D content.

The formats supported are shown in the following table.

For Blu-ray films	Frame Packing	1080p @ 23.98/24Hz
For 3D games	Frame Packing	720p @ 50 or 59.94/60Hz
For 3D films from broadcasters	Side by Side Horizontal	1080i @ 50 or 59.94/60Hz
	Top and Bottom	720p @ 50 or 59.94/60Hz 1080p @ 23.97/24Hz

Note:

- Refer to the user manual of the Grundig AS-3D G glasses for further information about usage, cleaning and care of the glasses.
- »HDMI4« input does not support HDMI 1.4.

SMART INTER@CTIVE TV AND HOME NETWORK

What is Smart Inter@ctive TV

Smart Inter@ctive TV provides your television with internet services and pages when connected to internet.

Through Interactive TV feature you can run many local and global internet applications. These applications include video, picture and music applications, social networks, news and sports, weather applications and doctor or pharmacy search, recipes and viewing traffic congestions depending on your local city.

Also, you can listen to online radio.

Your TV supports remote control feature for Apple iPhones and Android phones. Depending on the features of your TV, you may control your TV by your phone after downloading the free »GRUNDIG TV Remote« application from Apple App. Store or Android Market and install it on the Apple iPhone/Android phone.

The availability of the applications and the content is dependent on the content provider.

Network connection

You can establish a wired or wireless connection between your television and the local network.

If you want use a wired network connection, start with the instructions on this page;

if you use a wireless network connection, follow the instructions in section "Wireless network", on page 35.

Wired network

Wired network connection

- 1 Connect the output of external modem to the »LAN« socket with Cat 5 cable.

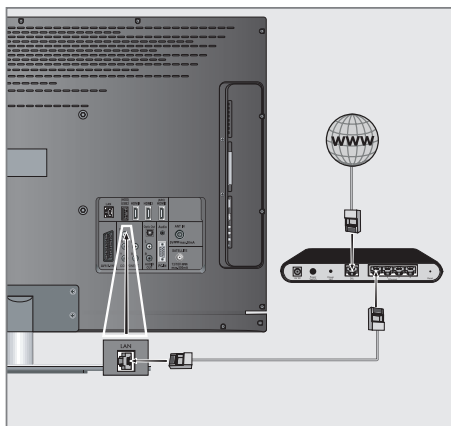

Note:

- Connection cables are not supplied.

SMART INTER@CTIVE TV AND HOME NETWORK

Wired network settings

There are two ways of making the wired network settings.

- A** Automatic wired network connection, all connection settings (»IP Address«, »Netmask«, »Gateway« and »DNS«) are obtained from modem automatically.
- B** Manual wired network connection, all connection settings (»IP Address«, »Netmask«, »Gateway« and »DNS«) must be configured manually.

Automatic wired network connection

Most of the home networks are Dynamic. If you have a dynamic network, you must use a DSL modem that supports DHCP. A Television connected to the same network with a Modem or IP sharer that support DHCP obtains the »DNS« values that are required for »IP Address«, »Netmask«, »Gateway« and internet access automatically, and thus you are not required to enter those values manually.

- 1 Open the menu with »**MENU**«.
- 2 Select the line »INTER@CTIVE TV« with »**V**« or »**A**« and press »**OK**« to confirm.
 - The »INTER@CTIVE TV« menu appears.

- 3 Select »Connection Type« with »**V**« or »**A**« and then select »Wired« with »**◀**« or »**▶**«.
- 4 Select »Network Configuration« with »**V**« or »**A**« and then select »AUTO« with »**◀**« or »**▶**«.
- 5 Start the registration to the home network by pressing »*« (red).
 - The message »Connecting ... Please Wait« appears.
- 6 Press »♦♦« (green) to make sure that the network connection is established with the current settings.
 - The messages »Testing ... Please Wait« appears, after successful announcement the messages »Connecting To Gateway: Success« and »Internet Connection: Success«.
- 7 Press »**MENU**« to end the setting.

Note:

- If you do not have a dynamic network, follow the instructions in manual connection section.

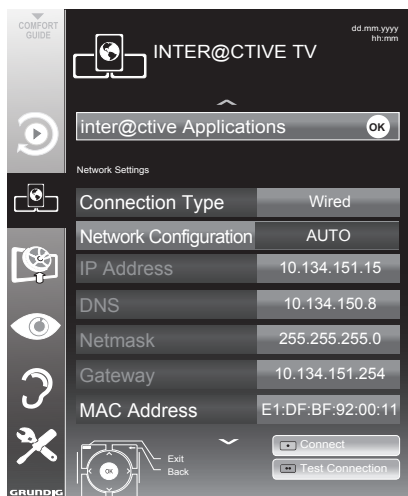

SMART INTER@CTIVE TV AND HOME NETWORK

Manual connection

Certain networks require Static IP address. If your network requires a Static IP address, you must enter the »IP Address«, »Netmask«, »Gateway« and »DNS« values manually. You can obtain your »IP Address«, »Netmask«, »Gateway« and »DNS« values from your Internet Service Provider (ISP).

- 1 Open the menu with **»MENU«**.
- 2 Select the line **»INTER@CTIVE TV«** with **»V«** or **»^«** and press **»OK«** to confirm.
- The **»INTER@CTIVE TV«** menu appears.
- 3 Select **»Connection Type«** with **»V«** or **»^«** and then select **»Wired«** with **»<«** or **»>«**.
- 4 Select **»Network Configuration«** with **»V«** or **»^«** and then select **»Manual«** with **»<«** or **»>«**.
- **»IP Address«, »Netmask«, »Gateway«** and **»DNS«** options are active.

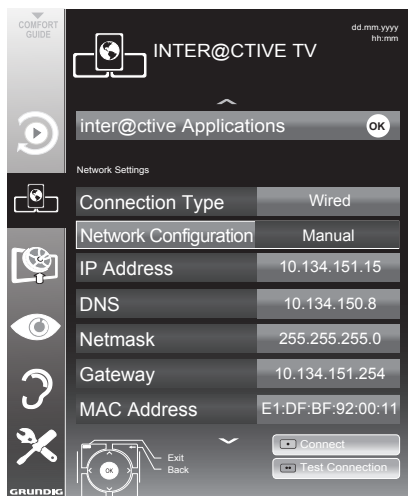

- 5 Select **»IP Address«** with **»V«** and press **»OK«**.
Enter the IP address with **»1...0«** and press **»♦♦«** (green) to save the value.
- 6 Select **»DNS«** with **»V«** and press **»OK«**.
Enter the DNS address with **»1...0«** and press **»♦♦«** (green) to save the value.

- 7 Select **»Netmask«** with **»V«** and press **»OK«**.
Enter the Netmask with **»1...0«** and press **»♦♦«** (green) to save the value.
- 8 Select **»Gateway«** with **»V«** and press **»OK«**.
Enter the Gateway with **»1...0«** and press **»♦♦«** (green) to save the value.
- 9 Start the registration to the home network by pressing **»♦«** (red).
- The message **»Connecting ... Please Wait«** appears.
- 10 Press **»♦♦«** (green) to make sure that the network connection is established with the current settings.
- The messages **»Testing ... Please Wait«** appears, after successful announcement the messages **»Connecting To Gateway: Success«** and **»Internet Connection: Success«**.
- 11 Press **»MENU«** to end the setting.

SMART INTER@CTIVE TV AND HOME NETWORK

Wireless network connection

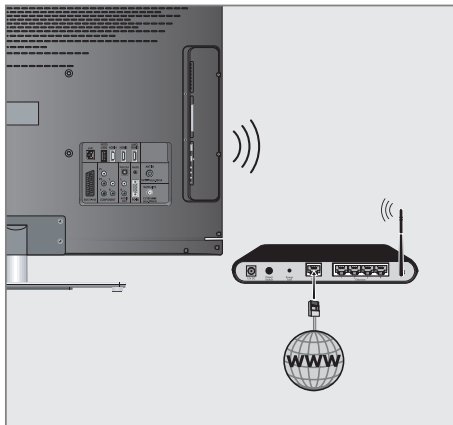

1 Television includes a built-in Wireless WiFi Adapter to connect it to wireless network.

Note:

- Apart from the built-in WiFi adapter on TV, external WiFi adapter can be connected to »USB1« and »USB2 (HDD)« inputs.

Notes:

- The GRUNDIG Wireless WiFi Adapter supports IEEE 802.11 B/G and N communication protocols. We recommend you to use IEEE 802.11N protocol to obtain the best performance in HD video playback.
- If you use a modem that supports IEEE 802.11B/G, video playback performance may be poor when compared to a modem that supports IEEE 802.11N since the data transfer rate of IEEE 802.11B/G protocol is lower.
- Please note that video playback performance in a DLNA application on a wireless local network and in a smart Inter@ctive TV application on a network with internet connection depends on the number of users on the network as it is the case in every wireless network.
- It is recommended to switch off the equipment that are not in use in home network in order to avoid unnecessary network traffic.
- Placing the modem or wireless network sharer on an elevated location will increase the wireless connection reception strength.
- Wireless connection reception strength may vary depending on the type of the modem, the distance between the modem and television and the distance between the device used as a DMS for DLNA application and the modem.
- Modem must be transmitting its SSID in order to establish a wireless connection. Television can not connect to a network without SSID.

SMART INTER@CTIVE TV AND HOME NETWORK

Wireless network settings

There are two ways of making the wireless network settings.

- A** Automatic connection,
»Apart from Access Point Selection, all data regarding the connection settings (»IP Address«, »Netmask«, »Gateway« and »DNS«) are obtained from modem automatically.
- B** Manual connection,
all connection settings (»IP Address«, »Netmask«, »Gateway« and »DNS«) must be configured manually.

Automatic connection

Most of the home networks are Dynamic. If you have a dynamic network, you must use a DSL modem that supports DHCP. Modems and IP sharers that support DHCP obtain the »DNS« values that are required for »IP Address«, »Netmask«, »Gateway« and internet access automatically, and thus you are not required to enter those values manually.

- 1 Open the menu with »MENU«.
- 2 Select the line »INTER@CTIVE TV« with »▼« or »▲« and press »OK« to confirm.
 - The »INTER@CTIVE TV« menu appears.

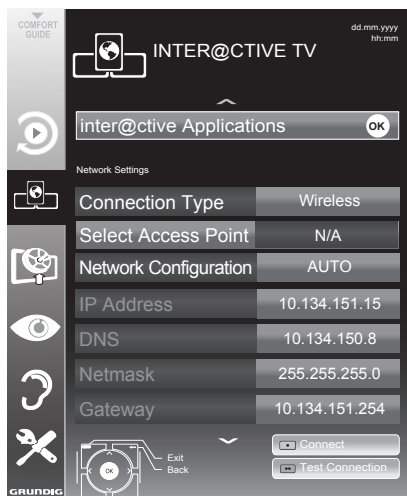

- 3 Select »Connection Type« with »▼« or »▲« and then select »Wireless« with »◀« or »▶«.

- 4 Select »Network Configuration« with »▼« or »▲« and then select »AUTO« with »◀« or »▶«.
- 5 Select »Select Access Point« with »▼« or »▲« and confirm with »OK«.
 - »Select Access Point« menu appears and available wireless networks are scanned and displayed in the menu
- 6 Select the network that you want to connect with »▼«, »▲«, »◀« or »▶« and confirm with »OK«.
 - Wireless connection password screen is displayed.
- 7 Select the required character with »▼«, »▲«, »◀« and »▶« and move to the next character with »OK«.
 - Select »ABC« for uppercase and »abc« for lower case and confirm with »OK«.
 - Select »?@123« for numbers and symbols and confirm with »OK«.
 - Enter the password, select »Confirm« with »▼«, »▲«, »◀« or »▶« and confirm with »OK«.

Note:

- In WEP encryption system, more than one network password can be assigned for the network. Your television can only connect to network with level 1 password.
- 8 Start the registration to the home network by pressing »*« (red).
 - The message »Connecting ... Please Wait« appears.
 - 9 Press »***« (green) to make sure that the network connection is established with the current settings.
 - The messages »Testing ... Please Wait« appears, after successful announcement the messages »Connecting To Gateway: Success« and »Internet Connection: Success«.

- 10 Press »MENU« to end the setting.

Note:

- If you do not have a dynamic network, follow the instructions in manual connection section.

SMART INTER@CTIVE TV AND HOME NETWORK

Manual connection

Certain networks require Static IP address. If your network requires a Static IP address, you must enter the »IP Address«, »Netmask«, »Gateway« and »DNS« values manually. You can obtain your »IP Address«, »Netmask«, »Gateway« and »DNS« values from your Internet Service Provider (ISP).

- 1 Open the menu with **»MENU«**.
- 2 Select the line »INTER@CTIVE TV« with **»▼«** or **»▲«** and press **»OK«** to confirm.
- The »INTER@CTIVE TV« menu appears.
- 3 Select »Connection Type« with **»▼«** or **»▲«** and then select »Wireless« with **»◀«** or **»▶«**.
- 4 Select »Select Access Point« with **»▼«** or **»▲«** and confirm with **»OK«**.
- »Select Access Point« menu appears and available wireless networks are scanned and displayed in the menu
- 5 Select the network that you want to connect with **»▼«, »▲«, »◀«** or **»▶«** and confirm with **»OK«**.
- Wireless connection password screen is displayed.
- 6 Select the required character with **»▼«, »▲«, »◀«** and **»▶«** and move to the next character with **»OK«**.
- Select **»ABC«** for uppercase and **»abc«** for lower case and confirm with **»OK«**.
- Select **»?@123«** for numbers and symbols and confirm with **»OK«**.
- Enter the password, select **»Confirm«** with **»▼«, »▲«, »◀«** or **»▶«** and confirm with **»OK«**.

Notes:

- In WEP encryption system, more than one network password can be assigned for the network. Your television can only connect to network with level 1 password.
- For TV to discover the wireless modem on the network, the network name should support ASCII characters.

- 7 Select »Network Configuration« with **»▼«** or **»▲«** and then select »Manual« with **»◀«** or **»▶«**. »IP Address«, »Netmask«, »Gateway« and »DNS« options are active.
- 8 Select »IP Address« with **»▼«** and press **»OK«**. Enter the IP address with **»1...0«** and press **»♦♦«** (green) to save the value.
- 9 Select »DNS« with **»▼«** and press **»OK«**. Enter the DNS address with **»1...0«** and press **»♦♦«** (green) to save the value.
- 10 Select »Netmask« with **»▼«** and press **»OK«**. Enter the Netmask with **»1...0«** and press **»♦♦«** (green) to save the value.
- 11 Select »Gateway« with **»▼«** and press **»OK«**. Enter the Gateway with **»1...0«** and press **»♦♦«** (green) to save the value.
- 12 Start the registration to the home network by pressing **»*«** (red).
- The message »Connecting ... Please Wait« appears.
- 13 Press **»♦♦«** (green) to make sure that the network connection is established with the current settings.
- The messages »Testing ... Please Wait« appears, after successful announcement the messages »Connecting To Gateway: Success« and »Internet Connection: Success«.
- 14 Press **»MENU«** to end the setting.

SMART INTER@CTIVE TV AND HOME NETWORK

Smart Inter@ctive TV internet applications

Smart Inter@ctive TV applications provide internet services to your television. These applications are designed according to your television.

With the Smart Inter@ctive TV feature you can access many local and global internet applications. These applications include video, picture and music applications, social networks, news and sports, weather applications and doctor or pharmacy search, recipes and viewing traffic congestions depending on your local city.

You can listen to online radios and access many other entertaining information.

Notes:

- Availability of Smart Inter@ctive TV applications are dependent on the country.
- Interactive TV internet applications cannot download and save files, cannot upload files to a web site and cannot install add-ins except Login pages of some applications.
- Under no circumstances, Grundig is responsible for the content and the quality of content offered by the content providers.
- Grundig has made special agreements with the application owners which have a limited duration. Application owners may update, modify, restrict or entirely remove those applications with their own decision. Grundig cannot be held responsible for such changes.
- Grundig reserves the right to make all changes such as modifications, restrictions, extensions, transfers and removals on internet applications provided through your Smart Inter@ctive TV.
- In Login process of some applications, it may be required to connect to the web page of the related application. Subject web pages may contain links not related to Login process. When connecting those links, TV may access open web and view contents that are not supported by your TV. As you are on open web, your TV cannot control those unsupported contents or cannot be held responsible for them.

Selecting internet applications

- 1 Open the menu »SMART inter@ctive TV« with »@«.

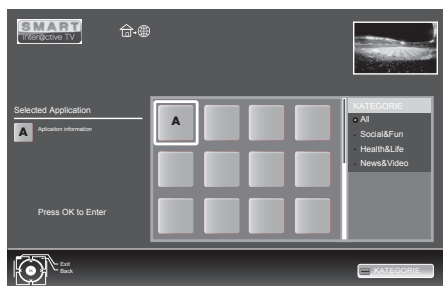

- 2 Select the application with »▼«, »▲«, »◀« and »▶« and press »OK« to confirm. The selected application will be started.

Notes:

- You can advise the applications also by categories, press »♦♦♦♦« (blue) and select with »▼« or »▲« the categorie and confirm with »OK«.
- If you attempt to start an application without wire or wireless adaptor connected, the related warning is displayed on the screen. If your wire or wireless adaptor is connected but you cannot receive IP or internet is not connected, the applications cannot be started. In this case, check Network connection settings. See page 31 or 34.

SMART INTER@CTIVE TV AND HOME NETWORK

Smart Inter@ctive browser main menu

- 1 Application gallery
- 2 Selected applications
- 3 Description of the application
- 4 Live picture from the current TV channel
- 5 Submenü for selecting the different categories.

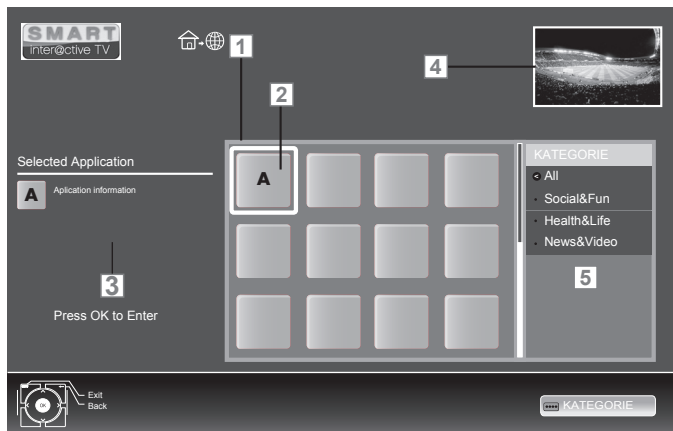

Navigation in the main menu

- 1 Select the desired application with »V«, »^«, »<« and »>« and press »OK« to confirm.
 - The main menu of the application appears after a short time.

Note:

- You can advise the applications also by categories, press »♦♦♦♦« (blue) and select with »V« or »^« the categorie and confirm with »OK«.
- 2 The further using is dependent of the structure from the application. See the notes on the screen.

Playing and other options in the applications

Note:

- Some applications do not support all playing options, and playing options may vary among different applications.

- 1 »▶▶« starts playback in the applications.
- 2 »||« pauses playback in the applications.
- 3 »■« stops playback in the applications.
- 4 Press »◀◀« or »▶▶« during playback, select different speed backwards and forwards.
- 5 Press »|◀« or »▶|« during playback, selects the previous or the next section.
- 6 Press »^«, »V«, »<«, »>« to slide the screen up and down, left and right in the virtual keyboard and applications.
- 7 Press »OK« to confirm the selections in virtual keyboard and applications.
- 8 Press »1...0«, »<« (red), »♦♦♦« (green), »♦♦♦« (yellow), »♦♦♦♦« (blue) to select/enable various functions in the applications.
- 9 Press »GUIDE« to end the application.

SMART INTER@CTIVE TV AND HOME NETWORK

Playback the video, music and image files with home network connection

With DLNA menu of your television, you can easily access Video, music and photo files on server; and thanks to DMR feature, you can automatically start and stop media playing on devices with DMC feature.

Notes:

- You can share your videos, music or photographs via devices such as a PC, Mobile Phone or NAS (Network Attached Storage) functioning as a DLNA compatible DMS (Digital Media Server).
- If the DMS device and the television are connected to the wireless network at the same time, laggings or freezing can arise during video playback.
- TV can also operate with DMS software installed in the computer, however, a full compatible operation with software without DMS certificate is not guaranteed.
- When you are using a PC with Windows OS, you can configure the Windows Media Player (from version 11) as Digital Media Server.

The required settings are related to the software version.

Select the Digital Media Server

- 1 Open the menu »SMART inter@ctive TV« with »@«.
- 2 Select the option »dlna« with »▼«, »▲«, »◀« or »▶« and confirm with »OK«.
– »dlna« menu is displayed.

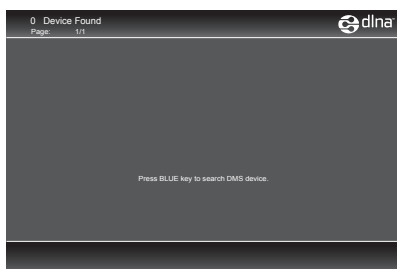

- 3 Press »♦♦♦♦« (blue) to discover DMS devices on home network.
 - DMS devices that are discovered appears in the menu.

Note:

- If no DMS device appears, check the network connection. See page 31 or 34.
- 4 Select the desired DMC device with »▼«, »▲«, »◀« or »▶« and display its content with »OK«.

Notes:

- File and folder structure of the DMS device in menu may vary depending on the Digital Media Server software in use.
- Subtitles are not supported on video files that are played through the DMS device.
- Only the formats with a DLNA certificate (»MPEG_PS_NTSC«, »MPEG_PS_PAL«, »MPEG_TS_SD_EU« and »MPEG_TS_EU_ISO«) are supported from among the video files played from DMS device.
- With high bitrate videos, distortion can be seen.
- Folders that appear as unknown in DLNA application cannot be played by the TV. Installing the codec to your computer can solve this problem.
- Only the formats with a DLNA certificate (»AAC_ADTS_320«, »LPCM«, »MP3«, »WMABASE« and »WMAFULL«) are supported from among the audio files played from DMS device.
- Only the formats with a DLNA certificate (»JPEG_LRG«, »JPEG_MED« and »JPEG_SM«) are supported from among the picture files played from DMS device.

SMART INTER@CTIVE TV AND HOME NETWORK

Start playback

- 1 In the content of the DMC device select the required folder with »**V**«, »**A**«, »**<**« or »**>**« and confirm with »**OK**«.
– All titles appears.
- 2 Select the required title with »**V**«, »**A**«, »**<**« or »**>**«.
- 3 Start playback with »**▶**«.

Other playback functions

- 1 Press »**||**« to pause playback.
- 2 Press »**▶**« to resume playback.
- 3 Press »**|◀**« or »**▶|**« repeatedly until the desired file is reached.
- 4 Press »**■**« to stop playback.
- 5 Press »**←**« to return to the DMS list page.
- 6 Press »**GUIDE**« to exit the DLNA function.

Note:

- This playback functions and others you can also select with the function menu:
 - »**FAV**« opens/closes playback functions menu;
 - »**▶**« starts playback;
 - »**||**« pause playback;
 - »**■**« stop playback;
 - »**◀◀**« and »**▶▶**« search for a passage;
 - »**⌂**« select the repeat function;
 - »**≡**« select the playlist;
 - »**i**« displaying title informations.

vTuner internet radio

Many radio stations broadcast through the internet. vTuner allows you to access many popular radio stations on earth. Thanks to the vTuner function of your television, you can display a list that contains many radio stations, and select and listen to the desired stations based on your tastes.

Note:

- Internet connection is required to use vTuner function.
- 1 Open the menu »SMART inter@ctive TV« with »**@**«.
 - 2 Select »vTuner« with »**V**«, »**A**«, »**<**« or »**>**« and confirm with »**OK**«.
– »Internet Radio« menu is displayed.



- 3 Select the required category with »**V**« or »**A**« and display its content with »**OK**«.
– »Select radio station with »**V**« or »**A**« and press »**OK**« or »**▶**«.
– Press »**■**« to end playback.

Note:

- Sequence and the names of files and folders in vTuner menu is updated by the vTuner server. Thus, it may vary.
- 4 Press »**←**« to return to the previous category.
 - 5 Press »**GUIDE**« to exit the vTuner function.

Information on recording and playing television programmes

- Recording and playback of television programmes is only possible with digital television channels (DVB-S, DVB-T and DVB-C).
- The digital television channels (DVB-S, DVB-T and DVB-C) you are able to record and playback also depends on the broadcaster.
- Recording and playback of programmes, as well as the time shift function, can only be carried out using an external data medium (hard drive or USB stick). The data medium should have a minimum storage capacity of 2 GB.
- Recordings can be made with most data media on the market. However, we cannot guarantee operation for all data media.
- If a programme was recorded on an external data medium, it can only be played back on your television set. The playback of these programmes is not possible on other devices.
- If you send your television to be repaired and hardware components need to be replaced, you might not be able to play the recordings again on the repaired television.
- Reception for SKY broadcasting service is currently only possible in Germany with a suitable set-top box or suitable CA module.
- Grundig does not accept liability for any loss of saved data on an external data medium.

Possible limitations when using an external data medium

Depending on the broadcaster, you may experience various restrictions on some of the functions from some television channels.

GRUNDIG has no influence on these restrictions.

- Recording a programme on the external data medium can be disabled by the broadcaster. If the message »URI* protected! PVR function is blocked« appears on the screen, then recording or timeshift is restricted (one recording possible) or disabled (recording not possible) by the broadcaster.
* URI = User right information (Copyright information).
- If you record and save a programme on the archive of an external data medium, playback can be restricted.
The broadcaster can allow you to view this programme one or more times, but it may only be available for a certain period of time.
- Programmes not suitable for minors will require the input of a PIN number immediately before recording starts. If this authorisation is not given, the recording may not start.
- Copying a programme from a digital television channel onto a video or DVD recorder using the »AV 1« socket (analogue picture/sound signal) can also be restricted by the broadcaster. Prerequisite is that your device supports the copying function.

USB RECORDING

Connecting external data media

Notes:

- Before connecting the data medium, switch the television to standby with **»U«**. Connect the device and then switch the television on again.
- Before removing the external data medium, the television must be switched to standby, so that no data loss occurs.
- Your television features two USB sockets, **»USB1«** and **»USB2 (HDD)«**. **»USB2(HDD)«** is used to connect data media, which require an additional power supply - for example, external hard disks.

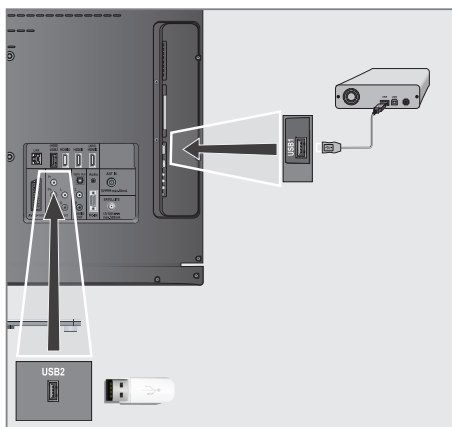

- 1 Connect the **»USB2 (HDD)«** socket of the television and the corresponding socket of the data medium (external hard disk) using a USB cable;

or

insert the USB plug of the USB memory stick into the **»USB1«** socket of the television.

- 2 Confirm the display **»USB«** with **»•••«** (green).
 - The file browser appears.

Notes:

- The **»USB1«** socket of the television supplies a maximum power of 500 mA in accordance with USB specifications. External hard disks which require more power may therefore only be connected to the **»USB2 (HDD)«** of the television.
- If you use a network cable for external hard disks which have been connected to the **»USB2 (HDD)«** socket of the television, this network cable must also be disconnected from the power supply when the television is switched off.
- External data media may not be disconnected from the television while files on the data medium are being accessed.

Settings for USB recording

Selecting the menu

- 1 Open the menu with **»MENU«**.
- 2 Select the line **»USB RECORDING«** with **»V«** or **»^«** and press **»OK«** to confirm.
 - The **»USB RECORDING«** menu appears.



USB RECORDING

Switching on automatic preview

If the automatic preview is switched on, a preview of the selected file appears in the file browser.

- 1 Select the line »Auto Preview« with »**V**« or »**^**«.
- 2 Switch on the function with »**<**« or »**>**« (»On«).
- 3 Press »**MENU**« to end the setting.

Safely remove disk

- 1 Select the line »Safely Remove Disk« with »**V**« or »**^**« and press »**OK**« to confirm.

Note:

- The disk can now be removed from the socket.

Selecting external data media

If several external data media are connected to the television, you can select the preferred data medium.

- 1 Select the line »Disk« with »**V**« or »**^**«
- 2 Select the preferred data medium with »**<**« or »**>**«.
- 3 Press »**MENU**« to end the setting.

Selecting a partition on the external data medium

If the external data medium features several partitions, select the partition you would like to use.

- 1 Select the line »Partition« with »**V**« or »**^**«.
- 2 Select the partition you wish to use with »**<**« or »**>**«.
- 3 Press »**MENU**« to end the setting.

Testing the external data medium

You can subject external data media to a test and establish whether they are suitable for the chosen functionality.

- 1 Select the line »Disk« with »**V**« or »**^**«. If several data media are connected, select the preferred data medium with »**<**« or »**>**«.
- 2 Select the line »Partition« with »**V**« or »**^**«. If several partitions are available, select the partition you wish to use with »**<**« or »**>**«.
- 3 Select the line »Check Disk« with »**V**« or »**^**« and press »**OK**« to confirm.
 - Information on the data medium is displayed.
- 4 Press »**MENU**« to end the setting.

“Pausing” time shift programmes

You can pause the programme you are watching. This is a useful function, for example if the telephone rings while you are watching a film and you do not want to miss anything.

A freeze-frame display of the last scene appears on the screen and the programme is recorded in the time shift memory of the external data medium.

In time shift mode you can record a maximum of 20 minutes of the current programme.

- 1 Press »**■**◀ to pause the current programme.
 - The picture is frozen, the time shift and the remaining recording time are displayed.
- 2 Press »▶◀ to resume the programme.
 - The programme will continue to be recorded.

Note:

- The following functions are possible when in time shift mode:
 - Rewind, press »◀◀ several times according to speed (the picture freezes while rewinding);
 - Fast forward, press »▶▶ several times according to speed;
 - Select pause with »**■**◀.
- 3 Press »**■**◀ to quit the time shift function.
 - The message »Live programme« appears, and you will see the current programme without time shift.
 - The scenes in the “time shift memory” are deleted.

Recording programmes

You can record programmes. The data for these programmes is recorded on an external data medium and this archive is administered via the television.

You need 44 MB till 110 MB of memory capacity on the external data medium for 1 minute recording time.

While recording, you can watch another programme from the archive.

You cannot change presets.



One-touch programme recording

- 1 Select the television channel to be recorded with »**1...0**◀ or »**P+**◀, »**P-**◀ and press »**■**◀ to start the recording.
 - Information on the recording is displayed: the recording symbol, the channel name, the programme, the recording time and the available memory space.
 - After a short time this information disappears.
- 2 End the recording with »**■**◀.
- 3 Confirm the display with »♦♦◀ (green);
or
press »♦◀ (red) to continue the recording.

Notes:

- After the recording is complete, the recording will be automatically saved on the external data medium.
- The »RECORDED FILES◀ menu, with the archived programmes, can be opened with »**REC.LIST**◀.
- If the external data medium is disconnected from the USB socket during recording, the recording will be stopped automatically and will not be saved.
- Play your recordings, that you have recorded with your FAT32 formatted HDDs, in USB mode.

Recording a programme from the channel list



- 1 Open the »CHANNEL LIST« with »OK«.
- 2 Select a television channel with »V«, »^«, »<« or »>« and press »OK« to confirm.
- 3 Press »MENU« to exit the channel list.
- 4 Press »« to start recording.
 - Information on the recording is displayed: the recording symbol, the channel name, the programme, the recording time and the available memory space.
 - After a short time this information disappears.
- 5 Press »« to stop recording.
- 6 Confirm the display with »♦♦« (green);
or
press »♦« (red) to continue the recording.

Presetting programmes to be recorded

... using the electronic TV guide

You can use data from the electronic TV guide for recording.

25 programmes can be preset for the timer recording or as a reminder.

- 1 Press »GUIDE« to display channel information.
 - The electronic TV guide appears.
- 2 Select the preferred channel with »V« or »^«.
- 3 Switch to the information about the current programme with »>«.
- 4 Select the programme of your choice with »V« or »^«.
- 5 Confirm the programme with »«.
 - The symbol »« appears after the name of the programme, and the data has been added to the timer.

Note:

- If the data for the recording is to be changed, use »♦♦♦« (yellow) and »♦♦♦♦« (blue) to switch to the »SCHEDULED EVENTS«, press »♦♦♦« (green), change the data and save it with »♦♦♦« (green).

- 6 Press »MENU« to exit the menu.

Notes:

- Before the timer recording begins, a warning message appears with a 20-second countdown. You can switch over to the programmed television channel.
- If the timer recording starts during playback, playback is not interrupted: Recording takes place automatically in the background as long as you do not select »Yes« when the timer countdown message is shown.

... by manual data entry

You can preset up to 25 programmes for timer recording.

- 1 Press **»GUIDE«** to display channel information.
– The electronic TV guide appears.
- 2 Open the **»MAKE SCHEDULE«** menu by pressing **»...«** (yellow) twice.
- 3 Select the line **»Type«** with **»▼«** or **»▲«** and select the option **»Recording«** with **»◀«** or **»▶«**.
- 4 Select the line **»Channel«** with **»▼«** or **»▲«** and select the channel with **»◀«** or **»▶«**.
- 5 Select the line **»Mode«** with **»▼«** or **»▲«** and select the preferred mode (**»Once«**, **»Every Day«** or **»Weekly«**) with **»◀«** or **»▶«**.
- 6 Select the line **»Start«** (Start recording) with **»▼«** or **»▲«** and enter the date/time with **»1...0«**.
- 7 Select the line **»End«** (Stop recording) with **»▼«** or **»▲«** and enter the date/time with **»1...0«**.
- 8 Save the data with **»...«** (green).
– The programme is preset.
- 9 Press **»MENU«** to exit the menu.

Notes:

- Before the timer recording begins, a warning message appears with a 20-second countdown. You can switch over to the programmed television channel.
- If the timer recording starts during playback, playback is not interrupted: recording takes place automatically in the background as long as you do not select **»Yes«** when the timer countdown message is shown.

Editing recording data in the timer menu

You can edit the data for programmed timer recordings.

- 1 Select the timer menu by pressing **»GUIDE«**, **»...«** (yellow) and **»...«** (blue) in succession.
– The **»SCHEDULED EVENTS«** menu appears.
- 2 Select the title of the programme to be changed with **»▼«** or **»▲«** and activate the timer position with **»...«** (green).
– The input menu is displayed.
- 3 Select the required option with **»▼«** or **»▲«** and edit the data with **»1...0«** and **»◀«** or **»▶«**.
- 4 Save the changes with **»...«** (green).
– The timer has been changed.
- 5 Press **»MENU«** to close the menu.

Deleting recording data in the timer menu

You can delete the data for programmed timer recordings.

- 1 Select the timer menu by pressing **»GUIDE«**, **»...«** (yellow) and **»...«** (blue) in succession.
– The **»SCHEDULED EVENTS«** menu appears.
- 2 Select the title of the programme to be deleted with **»▼«** or **»▲«** and delete the timer position with **»...«** (yellow).
- 3 Press **»MENU«** to close the menu.

Playback

The recorded programmes – whether started manually or using the timer function – are stored on the external data medium. You can open the archive on the external data medium by pressing **»REC.LIST«**.

Selecting a programme from the archive

- 1 Open the **»Recorded Event«** menu with **»REC.LIST«**.
 - The menu appears.
- 2 Select the programme of your choice with **»▼«** or **»▲«** and start playback with **»▶«**.
- 3 Press **»■«** to end playback.
 - The television switches over to the current television channel.

Forward/reverse picture search

- 1 During playback, select the fast forward speed (2x, 4x, 8x, 16x or 32x) with **»▶▶«**;
or
during playback, select the rewind speed (2x, 4x, 8x, 16x or 32x) with **»◀◀«** (the picture freezes when rewinding).

Repeating a scene (A-B)

You can mark the starting and ending point of a scene. The scene is then repeated continuously.

- 1 Mark the starting point A by pressing **»▶«** at the required scene during playback.
 - This scene is marked as the starting point A.
- 2 Mark the end point B by pressing **»▶◀«** once again at the required scene during playback.
 - This scene is marked as the end point B.
 - The television repeats the programme between these two points.
- 3 Quit the repeat function with **»■«**.

Playback during a recording

During a recording, you can either watch the programme you are currently recording or watch a different one that you have already recorded.

- 1 Select the channel to be recorded with **»1...0«** or **»P+«**, **»P-«** and press **»■◉«** to start the recording.
- 2 Select the **»Recorded Event«** menu by pressing **»REC.LIST«**.
- 3 Select the programme you want with **»▼«** or **»▲«** and press **»▶«** to start playback.
 - The recording continues in the background.
- 4 Press **»■«** to end playback.
- 5 Press **»■«** to stop recording.

Deleting programmes in the recording list

You can delete programmes from the recording list.

- 1 Open the **»Recorded Event«** menu with **»REC.LIST«**.
 - The menu appears.
- 2 Select the programme to be deleted with **»▼«** or **»▲«**.
- 3 Press **»••••«** (blue) to delete the programme.
- 4 Confirm the security query with **»••«** (green).

Note:

- You cannot delete programmes in the **»Recorded Event«** menu which are currently being recorded or played back.
- 5 Press **»MENU«** to close the menu.

USB OPERATION

File formats

Your television can work with the following file formats using the USB sockets:

Video data

Special codecs for video compression and decompression provide more memory space without compromising the picture quality excessively.

Your television plays video files in the formats DIVX, XVID, H.264/MPEG-4 AVC (L4.1, 4 reference pictures), MPEG-4, MPEG-2, MPEG-1, MJPEG and MOV.

The following file name extensions are also supported: AVI, MKV, MP4, TS, MOV, MPG, DAT, VOB. These files can also contain audio files compressed using MP3, AAC or Dolby Digital®.

Audio data

Your television can play audio data in the formats MP3, AAC, WMA.

MP3 is the abbreviation for MPEG-1 Level 3 and is based on the MPEG-1 standard, which was developed by the MPEG (Motion Picture Expert Group).

AAC stands for Advanced Audio Coding and was also developed by MPEG. AAC provides better sound quality at an identical data rate.

WMA (Windows Media Audio) is a compression standard for audio data developed by Microsoft.

These formats allow audio files to be recorded and played which sound as good as a CD, while taking up only a fraction of the memory space.

File name extensions which are supported: MP3, MP2, WMA, M4A, AAC.

MP3 files can be organised into folders and subfolders, as on the computer.

Image data

Your television can display pictures in the formats JPEG, PNG and BMP.

JPEG stands for Joint Picture Experts Group. It denotes a process for compressing picture files.

PNG and BMP are process used to save image data with no, or very little, losses.

Picture files can be stored with other types of files on one medium.

These files can be organised into folders and subfolders.

USB OPERATION

Connecting external data media

Before connecting the data medium, switch the television to standby using »«. Connect the device and then switch the television on again.

Before removing the external data medium, the television set must be switched to standby, so that no data loss occurs.

Notes:

- The »**USB1**« socket of the television set supplies a maximum power of 500 mA in accordance with USB specifications. External hard disks which require more power may therefore only be connected to the »**USB2 (HDD)**« of the television set.
- If you use a network cable for external hard disks which are connected to the »**USB2 (HDD)**« socket on the television, this network cable must also be disconnected from the power supply when the television is switched off.
- External data media may not be disconnected from the television set while files on the data medium are being accessed.
- A bi-directional data transfer as defined for ITE (Information Technology Equipment) devices in EN 55022/EN 55024 is not possible.
- USB transfer is not in itself an operating mode. It is only an additional function.

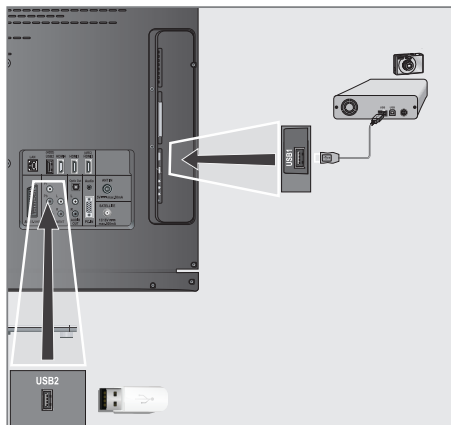

- 1 Connect the »**USB2 (HDD)**« socket of the television and the corresponding socket on the data device (external hard drive, digital camera, card reader or MP3 player) using a USB cable;

or

insert the USB plug of the USB memory stick into the »**USB1**« socket of the television set.

- 2 Confirm the display »« with »••« (green).
 - The file browser appears.

USB OPERATION

The file browser

The file browser displays video, audio and picture files stored on external data media.

If an external data medium contains files in different formats, you can, when necessary, filter out the formats not required.

Main menu of the file browser

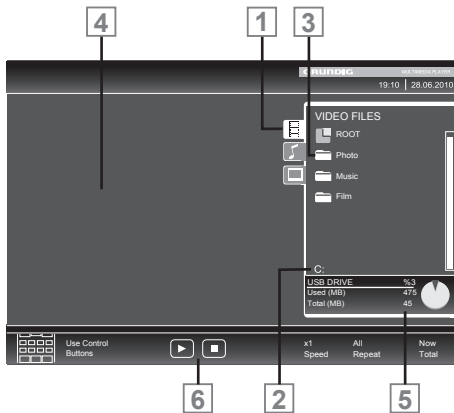

- 1 Selected data format.
- 2 Name of the data medium.
- 3 Total number of folders on the data medium.
- 4 Preview of the selected file.
- 5 Information on the external data medium.
- 6 Menu navigation.

Settings in the USB setup menu

Selecting the menu

- 1 Press **»→◀«**, use **»▼«**, **»▲«**, **»◀«** or **»▶«** to select the preset **»USB«** and press **»OK«** to confirm.
- 2 Open the menu with **»MENU«**.
- 3 Select the **»SOURCE SETUP«** menu item with **»▼«** or **»▲«** and press **»OK«** to confirm.
 - The **»SOURCE SETUP«** menu appears.

Note:

- Additional functions are explained in the following sections.

Switching on automatic preview

If this function is switched on, a preview of the selected file then appears in the file browser.

- 1 Select the line **»Auto Preview«** with **»▼«** or **»▲«**.
- 2 Switch on the function with **»◀«** or **»▶«** (**»On«**).

Note:

- Viewing mode can not be change while 3D mode is active.
- 3 Press **»MENU«** to end the setting.

Selecting the display mode

- 1 Select **»View Mode«** with **»▼«** or **»▲«**.
- 2 Select the preferred option with **»◀«** or **»▶«**.
- 3 Press **»MENU«** to end the setting.

Setting the display duration for pictures in a slideshow

- 1 Select **»Slide Show Interval«** with **»▼«** or **»▲«**.
- 2 Select the display duration (3, 5, 10 seconds) with **»◀«** or **»▶«**.
- 3 Press **»MENU«** to end the setting.

USB OPERATION

DivX® VOD

You must have your device registered in order to play the protected video that you will buy from DivX®.

- 1 Select »DivX® VOD« with »▼« or »▲« and confirm with »OK«.
- Registration Code appears.
- 2 Visit "http://vod.divx.com" and register the device with the registration code.
- 3 Press »MENU« to end the setting.

DivX⁺ HD DivX Certified® to play DivX® and DivX Plus™ HD (H.264/MKV) video up to 1080p HD including premium content.

ABOUT DIVX VIDEO: DivX® is a digital video format created by DivX, Inc. This is an official DivX Certified® device that plays DivX video. Visit divx.com for more information and software tools to convert your files into DivX video.

ABOUT DIVX VIDEO-ON-DEMAND: This DivX Certified® device must be registered in order to play purchased DivX Video-on-Demand (VOD) movies. To obtain your registration code, locate the DivX VOD section in your device USB setup menu. Go to vod.divx.com for more information on how to complete your registration.

Basic playback functions

- 1 Select the data medium by pressing »▶◀«, use »▼«, »▲«, »◀« or »▶« to select the option »USB« and press »OK« to confirm.
- The file browser appears.
- 2 Select the file format (video files, audio files, picture files) with »▼« or »▲«.
- 3 Switch to the folder/file list with »OK«.

Note:

- USB data medium with several partitions is connected to the USB sockets, the letter for the respective drive (e.g. C) appears behind the folder symbol. Select the letter of the drive with »▼« or »▲« and press »OK« to confirm.
- 4 Select the folder or file with »▼« or »▲« and press »OK« to open it.
- A list of subdirectories appears.

Note:

- Switch back to the main folder with »◀«.
- 5 Select the track or picture with »▼« or »▲« and press »▶« to start playing.
- You can view information on the film data by pressing »?«.
- When playing MP3 or WMA data, information on the album, track and singer is displayed at the left of the menu.
- When playing picture files, you can use »?« to display information about the resolution and size.
- When playing picture data, press »?« twice to enter the DivX® Settings menu.

Note:

- When playing picture data, the file browser switches off. Press »■« to display the file browser again.
- 6 Press »■« to pause playback.
 - 7 Press »▶« to resume normal playback.
 - 8 Press »■« to end playback.
The file browser appears.

Notes:

- Use »^« to select »Up Folder«, when you would like to return to the last folder. Use »Root« (and then press »OK«) to return to the main folder.
- It is possible that files which are actually supported do not function correctly in USB mode. This is because certain files are not recorded with standardised compression processes, although they feature the "right" file ending.
- If a video file features several audio tracks (audio streams), you can switch these over during playback in full screen mode with »?«.
- When playing music files, you can use other options in the USB mode at the same time. This way, you can, for example, enhance a slideshow with music.
- For films, only subtitles in the .SRT, .ASS, .SSA, .SMI format are supported. The names of the subtitle and film files must be identical. Otherwise, no subtitles will be shown.

Subtitle function is only supported in movies that you will watch in 3D mode.

Additional playback functions

Depending on the file format, the following additional functions are available:

Selecting chapters on DivX® files

(only video files)

- 1 During playback, select the next chapter with »>«.
- 2 During playback, select the previous chapter with »<«.

Note:

- You can also select chapters by entering the chapter number with »1...0«.

Selecting titles on DivX® files

(only video files)

- 1 During playback, select the next title with »^«.
- 2 During playback, select the previous title with »v«.

Playing selected titles

Only the marked tracks are played.

- 1 Select the titles with »v« or »^« and press »OK« to mark it.
- 2 Select the next title with »v« or »^« and press »OK« to mark it.
- 3 Start playback with »▶«.
- 4 Press »■« to end playback.

Note:

- To remove the marking, select the title with »v« or »^« and press »OK« to remove the marking.

USB OPERATION

Selecting a track or picture in steps (SKIP)

- 1 During playback, select the next track/picture with »▶«.
- 2 During playback, select the previous track/picture with »|◀«.
- Playback begins with the track or picture you selected.

Selecting a certain passage for playback

(video files only)

- 1 During playback, press »OK«.
- 2 Enter the passage (time) with »1 ... 0« and press »♦♦« (green) or »OK« to confirm.

Fast forward

(for video and audio files only)

You can select different speeds (2-fold, 4-fold, 8-fold, 16-fold and 32-fold forwards and backwards).

- 1 Select the playback speed during playback with »◀◀« or »▶▶«.
- 2 Press »▶« to resume normal playback.

Rotating pictures

(picture files only)

You can rotate pictures by 90°.

- 1 During playback, press »◀« or »▶« to rotate the pictures by 90°.

Repeat functions

Options:

- »One Repeat«: the current track will be repeated.
- »All Repeat«: all tracks will be repeated.

- 1 Switch off the repeat function before playback with »TOOLS«.
- 2 Start playback with »▶«.
- 3 Deactivate the repeat function with »TOOLS«.
- The display changes to »None Repeat«.

TELETEXT OPERATION

TOP text or FLOF text mode

- 1 Press »TXT« to switch on teletext.
- 2 Select teletext pages directly with »1...0« or step by step with »▼« and »▲«.
Return to teletext page 100 with »?«.

Note:

- At the bottom of the screen there is an info bar with red, green and – depending on the channel – yellow and blue panels. Similarly, the remote control also features buttons with different colours with which these pages can be selected.

- 3 Go back a page with »*« (red).
- 4 Go to the next page with »**« (green).
- 5 Select a particular chapter with »***« (yellow).
- 6 Select a particular subject with »****« (blue).
- 7 Quit teletext with »TXT«.

Normal text mode

- 1 Press »TXT« to switch on teletext.
- 2 Press »1...0« to select teletext pages directly.
Return to teletext page 100 with »?«.
- 3 Go back a page with »▼«.
- 4 Go to the next page with »▲«.
- 5 Quit teletext with »TXT«.

Note:

- Teletext feature is not supported in 3D mode.

Additional functions

Skipping the waiting time

While a page search is progressing, you can switch to the TV programme.

- 1 Enter the teletext page number with »1...0« and then press »▶|«.
– As soon as the page is found, the page number is displayed.
- 2 Press »▶|« to switch to the teletext page.

Enlarging the character height

If you have difficulty reading the text on the screen, you can increase the character height.

- 1 To enlarge the character height of a teletext page, keep pressing »|◀«.

Page hold

A multiple page may contain several sub-pages, which are automatically scrolled by the broadcasting station.

- 1 Stop the automatic scrolling of the sub-pages with »◀◀«.
- 2 Quit the function with »◀◀«.

Opening a sub-page directly

If the selected teletext page contains additional pages, the number of the current sub-page and the total number of pages are displayed.

- 1 Press »☐◀« to open the sub-page function.
- 2 Use »◀« or »▶« to select the sub-page.
- 3 Quit the function with »☐◀«.

Revealing answers

Certain teletext pages contain hidden answers or information.

- 1 Display information with »▶▶«.
- 2 Press »▶▶« to conceal the information.

Split screen

This functions allows you to display the television channel on the left side, the teletext on the right side.

- 1 Switch the function on with »■◀«.
– The television channel and teletext are displayed next to each other.
- 2 Switch the function off with »■◀«.

INTERACTIVE PORTAL (HBBTV)

What is HbbTV?

To put it simply, HbbTV provides next-generation interactive teletext with modern structured content, high-definition pictures and video sequences, and interactivity.

To receive HbbTV, the television must be connected to the internet.

ARD is currently offering this new service with its "third programmes", as is ZDF.

The ARD offering includes, for example, a detailed programme overview, the full offering of "Das Erste¹Mediathek" as well as graphical re-structured teletext with high-definition pictures. The ZDF offering includes the "ZDF mediathek" and other programme information (as of September 2011).

The HBBTV Service is only available in some countries.

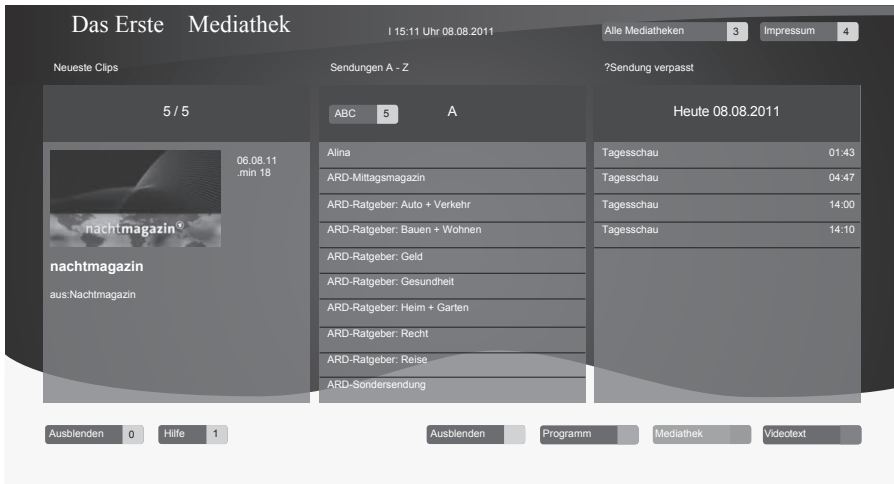

HbbTV Operation

When you switch to a TV programme that supports HbbTV, an information message is displayed if HbbTV is available.

- 1 Switch on HbbTV with »*« (red).
 - Information about the service is displayed on the screen. In addition, the coloured keys required for navigation are also displayed.

Note:

- The range of subject areas and the selection of the individual subject areas is dependent on the each programme provider.
- The number buttons »1« to »0« are used for additional functions.

- 2 Select your required subject area with »*« (green), »***« (yellow) or »*****« (blue).
- 3 In your selected subject area, choose the required option using »▼«, »▲«, »◀« or »▶« and confirm with »OK«.
- 4 Switch on HbbTV with »*« (red).

Additional functions for video sequences

- 1 Start playback with »▶«.
- 2 Pause playback with »||«.
- 3 Continue playback with »▶«.
- 4 Rewind with »◀◀« or forward with »▶▶«.
- 5 Stop playback with »■«.

CONVENIENCE FUNCTIONS

Opening the SETTINGS menu

- 1 Open the menu with »MENU«.
- 2 Select the »SETTINGS« menu with »V« or »^« and press »OK« to confirm.
 - The »SETTINGS« menu appears.



Note:

- Additional operations are explained in the following sections.

Language settings

Changing the menu language

- 1 Select the line »Menu« with »V« or »^« and press »OK« to confirm.
 - The »Select Menu Language« menu appears.
- 2 Select the menu language with »<«, »>«, »V« or »^« and press »OK« to confirm.
- 3 Press »MENU« to finish the setting.

Changing the audio language

(only for digital television channels)

You can define a primary and a secondary audio language.

- 1 Select the line »Audio« with »V« or »^« and press »OK« to confirm.
 - The »Select Audio Language« menu appears.
- 2 Select the audio language with »<«, »>«, »V« or »^« and then use »*« (red) to set it as the primary audio language, or use »**« (green) to set it as the secondary audio language.
 - The primary and secondary language is displayed at the top right in the menu.
- 3 Press »MENU« to end the setting.

Changing the subtitle language and subtitle mode

(only for digital television channels)

You can switch the subtitles on and off, select the subtitle language and allocate a second subtitle language.

- 1 Select the line »Subtitle« with »V« or »^« and press »OK« to confirm.
 - The »Select Subtitle Language« menu appears.
- 2 Select the subtitle language with »V«, »^«, »<« or »>«, then use »*« (red) to set it as the primary subtitle language, or use »**« (green) to set it as the secondary subtitle language.
 - The primary and secondary language is displayed at the top right in the menu.
- 3 To go back one menu level, press »←«.
- 4 Select the line »Subtitle Mode« with »V« or »^« and then set the preferred option »Off«, »Hard of Hearing« or »Basic« with »<« or »>«.
- 5 Press »MENU« to end the setting.

CONVENIENCE FUNCTIONS

Setting the date and time

Automatic setting

Your television set detects the difference in time to Greenwich Mean Time (GMT) automatically, as long as the channel selected transmits a time signal.

- 1 Select the line »Date & Time« with »V« or »^« and press »OK« to confirm.
- 2 Select the line »Auto« with »V« or »^« and press »OK« to confirm.
 - Date and Time will be updated automatically;

or
- 3 Select the input box with »V« or »^«, enter the data for Date and Time with »1...0« and press »OK« to confirm.

Manual setting

You can also set the difference in time manually – for example, when the correct time is not detected automatically or does not correspond to local time for other reasons

- 1 Select the line »Time Adjustment« with »V«, then select the option »Manual« with »<« or »>«.
 - The lines »Time Zone« and »Daylight Saving« are active.
- 2 Select the line »Time Zone« with »V« and press »OK« to confirm.
 - The »Select Time Zone« menu appears.
- 3 Select the appropriate time zone with »<«, »>«, »V« or »^« and press »OK« to confirm.
- 4 Select the line »Daylight Saving« with »V« and use »<« or »>« to set the option »Auto«, »Off« or »On«.
- 5 Press »MENU« to finish the setting.

Note:

- If the option »Auto« is selected in the line »Time Adjustment«, the television set automatically adapts the time to the time signal from the respective broadcaster. However, different channels may also use time bases which are different to those of your country; e.g. foreign broadcasters. In these cases, reminders and planned recordings may be annulled due to the time difference.

Timer settings

Entering the switch-off time (sleep timer)

In the »Sleep Timer« menu you can enter a time for the television to switch off. After this time has elapsed, the television switches to standby mode.

- 1 Select the line »Sleep Timer« with »V« or »^«.
- 2 Enter the switch-off time with »<« or »>«.

Note:

- To switch off the function, use »<« or »>« to set the switch-off time to »Off«.

- 3 Press »MENU« to end the set-up.

Switch-on timer

In the »Auto On« menu you can enter a switch-on time for the television. After the preset time has elapsed, the television switches on from standby – at the preselected volume and the preselected television channel.

- 1 Select the line »Auto On« with »V« or »^« and press »OK« to confirm.
- 2 Select the line »Mode« with »V« or »^« and use »<« or »>« to select when the television should switch on.
- 3 Select the line »Input Source« with »V« or »^« and use »<« or »>« to select the input source.
- 4 Select the line »Service Type« with »V« or »^« and use »<« or »>« to select the preferred option (ATV, DTV, Radio or DATA).
- 5 Select the line »Channel« with »V« or »^« and use »<« or »>« to select the preferred channel.

Note:

- The line »Channel« is only active when the input signal currently in use has been set. If no entry has been made, then the first channel of the selected input source will be used.

CONVENIENCE FUNCTIONS

6 Select the line »Volume« with »V« or »^« and use »<« or »>« to set the volume.

7 Select the line »Set Hour« with »V« or »^« and enter the time with »1...0«.

8 Save the data with »♦« (green).

Note:

■ You can abort the entry by pressing »♦« (red).

9 Press »MENU« to end the setting.

Switch-off timer

In the »Auto Off« menu, you can enter a time for the television to switch off. After this time has elapsed, the television switches to standby mode.

1 Select the line »Auto Off« with »V« or »^« and press »OK« to confirm.

2 Select the line »Mode« with »V« or »^« and use »<« or »>« to set the preferred mode.

3 Select the line »Set Hour« with »V« or »^« and enter the time with »1...0«.

4 Save the data with »♦« (green).

Note:

■ You can abort the entry by pressing »♦« (red).

5 Press »MENU« to end the setting.

Automatic switch-off (Auto Sleep)

If this function is activated, the television switches automatically to standby after 5 minutes if no video signal is broadcast or in accordance with the according to European regulations, the television switches automatically to standby after 4 hours provided that none of the buttons on the remote control or on the television is operated during this period.

1 Select the line »Auto Sleep« with »V« or »^«.

2 Activate the function with »<« or »>« (»On«).

Note:

■ To switch off the function, use »<« or »>« to select the setting »Off«.

3 Press »MENU« to end the setting.

Parental control settings

Authorising programmes

There are films which may be wholly or partially unsuitable for children.

These programmes contain information which marks the content or scenes with access levels of 4 to 18. You can select one of the access levels, thereby authorising playback.

1 Select the line »Parental Guidance« with »V« or »^« and press »OK« to confirm.

2 Enter the PIN code »1234« with »1 ... 0«.

3 Select the access level with »<« or »>«.

4 Press »MENU« to end the setting.

Locking menus

This function allows you to lock the »Automatic Channel Search«, »Digital Manual Tuning«, »Analogue Manual Tuning« and »Program Table« menus so that they can be only accessed by entering a PIN code.

1 Select »Menu Lock« with »V« or »^«.

2 Enter the PIN code »1234« with »1 ... 0«.

3 Activate the lock with »<« or »>« (»On«).

Note:

■ To switch off the menu lock, use »<« or »>« to select the setting (»Off«).

4 Press »MENU« to end the setting.

Locking keys (Parental lock)

When the key lock is activated, the buttons on the television set do not function.

1 Select the line »Keypad Lock« with »V« or »^«.

2 Enter the PIN code »1234« with »1 ... 0«.

3 Activate (On) or deactivate (Off) the key lock with »<« or »>«.

4 Press »MENU« to end the setting.

CONVENIENCE FUNCTIONS

Changing the PIN code

You can also enter a personal PIN code instead of the default code »1234«. Please take note of your own PIN code.

- 1 Select »Set PIN« with »V« or »^« and press »OK« to confirm.
- 2 Enter the current PIN code 1 2 3 4 with »1 ... 0«.
- 3 Enter your new four digit PIN code with »1 ... 0«.
- 4 Enter your new four digit PIN code with »1 ... 0« again.
- 5 Press »MENU« to end the setting.

Locking television channels

You can lock individual television channels, for example channels unsuitable for children, using a personal PIN code.

- 1 Open the menu with »MENU«.
- 2 Select the »SOURCE SETUP« menu with »V« or »^« and press »OK« to confirm.
- 3 Select the line »Program Table« with »V« or »^« and press »OK« to confirm.
- The »PROGRAM TABLE« menu is displayed.
- 4 In the »PROGRAM TABLE« menu, switch over to the list view with »♦♦♦« (yellow).
- 5 Select the channel to be locked with »V« or »^«.
- 6 Select the column »Lock« with »<« or »>« and press »OK« to lock the channel.
- 7 Enter the PIN code »1234« with »1 ... 0«.
- The channel is marked using »✓«.

Note:

- To remove the lock, select the channel again with »V« or »^«, press »OK« to confirm and then enter the PIN code 1 2 3 4 using »1 ... 0«.
- 8 Press »MENU« to end the setting.

Updating software (OAD)

(from satellite, for digital channels only)

- 1 In the »SETTINGS« menu, select the line »Check For OAD Updates updates« with »V« or »^« and press »OK« to confirm.
- A search for new software will be made and - if available - it will be installed.

Note:

- If a search for software updates should be made automatically, select the line »Automatic OAD Update« with »V« or »^« and use »<« or »>« to select the option »On«.
- The software will be updated automatically as far as possible.
- 2 Press »MENU« to end the setting.

Updating software (Online)

(from the internet, for digital channels only)

- 1 In the »SETTINGS« menu, select the line »Check For Online Updates updates« with »V« or »^« and press »OK« to confirm.
- A search for new software will be made and - if available - it will be installed.

Note:

- If a search for software updates should be made automatically, select the line »Automatic Online Update« with »V« or »^« and use »<« or »>« to select the option »On«.
- The software will be updated automatically as far as possible.
- 2 Press »MENU« to end the setting.

Restoring the television to the default settings

This function allows you to delete the channel lists and all custom settings.

- 1 In the »SETTINGS« menu, select the line »Restore Factory Defaults« with »V« or »^« and press »OK« to confirm.
- 2 Press »♦♦♦« (green) to confirm the warning message.
- The »Source Setup« menu appears.
- 3 Continue the settings with the chapter "Initial set-up and tuning television channels" on page 14.

OPERATION USING EXTERNAL DEVICES

DIGI LINK



Your television is equipped with the DIGI LINK function.

This function uses the CEC (Consumer Electronics Control) protocol.

CEC allows external devices which are connected to the »HDMI« sockets by an HDMI cable (e.g. DVD player) to be operated with a remote control.

Prerequisite is that the devices connected support CEC. Read the operating manual for the external device to find out how to activate the corresponding function.

The DIGI LINK functions on your television

Switching on the television automatically from standby

If the »Autom. switch-on TV« function is activated (»On«), then once the external device (e.g. DVD player) is switched on, the television also switches on and the appropriate HDMI preset is selected.

Automatic selection of the HDMI preset on the television

If your television is switched on and you then switch on the external device (e.g. DVD player), the appropriate HDMI preset on the television will be selected.

Selecting the menu language

The television menu language is automatically selected on the external device (e.g. DVD player). The external device must support this function.

Switching off the external device automatically

If you switch your television to standby, the external device (if it is switched on) will also be switched to standby.

DIGI LINK is always active on your television set.

Searching for and activating external devices

You can connect up to 11 devices with DIGI LINK functions to your television.

- 1 Open the Tools menu with »**TOOLS**«.
- 2 Select the menu item »CEC« with »**V**« or »**^**« and press »**OK**« to confirm.
 - The »HDMI CEC Device List« appears.
- 2 Start the device search with »*« (red).
 - The devices found are displayed in the menu.
- 3 Select the device for operation with »**V**«, »**^**«, »**<**« or »**>**« and press »**OK**« to mark it.
 - If the selected device is connected to a different input to the current one, a switch to the respective input will occur automatically.
- 4 Press »**MENU**« to end the setting.

OPERATION USING EXTERNAL DEVICES

Device operation

You can decide whether external devices should react to your television's remote control.

- 1 Press **»→◀**, use **»V◀**, **»^◀**, **»◀◀** or **»▶▶** to select the preset **»HDMI1◀** to **»HDMI4◀** and press **»OK◀** to confirm.
- 2 Open the menu with **»MENU◀**.
- 3 Select the menu item **»SOURCE SETUP◀** with **»V◀** or **»^◀** and press **»OK◀** to confirm.
– The **»SOURCE SETUP◀** menu appears.

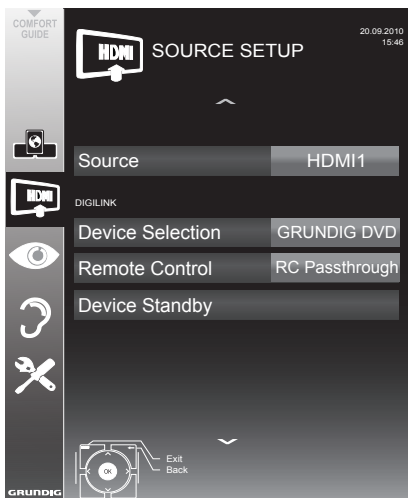

- 4 Select the line **»Remote Control◀** with **»V◀** or **»^◀**.
- 5 Select the type of operation (**»RC Passthrough◀**, **»Deck◀** or **»Tuner◀** with **»◀◀** or **»▶▶**).

Notes:

- **»RC Passthrough◀** can be used for all devices. **»Deck◀** and **»Tuner◀** can be selected in accordance with the external device which has been connected.
 - Try out which type of remote control operation the external device reacts to the best.
 - Read about the scope of functions of the DIGILINK-compatible device in the respective operating manual.
- 6 Press **»MENU◀** to end the setting.

Switching the device to standby

This option switches the external device to standby.

- 1 Press **»→◀**, use **»V◀**, **»^◀**, **»◀◀** or **»▶▶** to select the preset **»HDMI1◀** to **»HDMI4◀** and press **»OK◀** to confirm.
- 2 Open the menu with **»MENU◀**.
- 3 Select the menu item **»SOURCE SETUP◀** with **»V◀** or **»^◀** and press **»OK◀** to confirm.
– The **»SOURCE SETUP◀** menu appears.
- 4 Select **»Device Standby◀** with **»V◀** or **»^◀** and press **»OK◀** to confirm.
– The external device switches itself off.

OPERATION USING EXTERNAL DEVICES

High definition HD ready



Connect the corresponding input sources (e.g. HDTV receiver or HD-DVD player) to the »HDMI« sockets (for digital HDTV sources).

This ensures that you can view digital HDTV programmes, even if they are copy-protected (HDCP High Bandwidth Digital Content Protection), without encountering problems.

Connection options

- Which television socket(s) you connect your external devices to depends on the sockets the external device is equipped with and the signals which are available.
- Please note: With many external devices, the resolution of the video signal must be adjusted to the input sockets of the television (see the operating manual of the external device). You can find out which values you need to set by referring to the guidelines in the sections about the various connection options.
- Do not connect any other equipment while the device is switched on. Also switch off the other equipment before connecting it.
- Do not plug in the power cord of the device until you have connected the external equipment and the antenna.

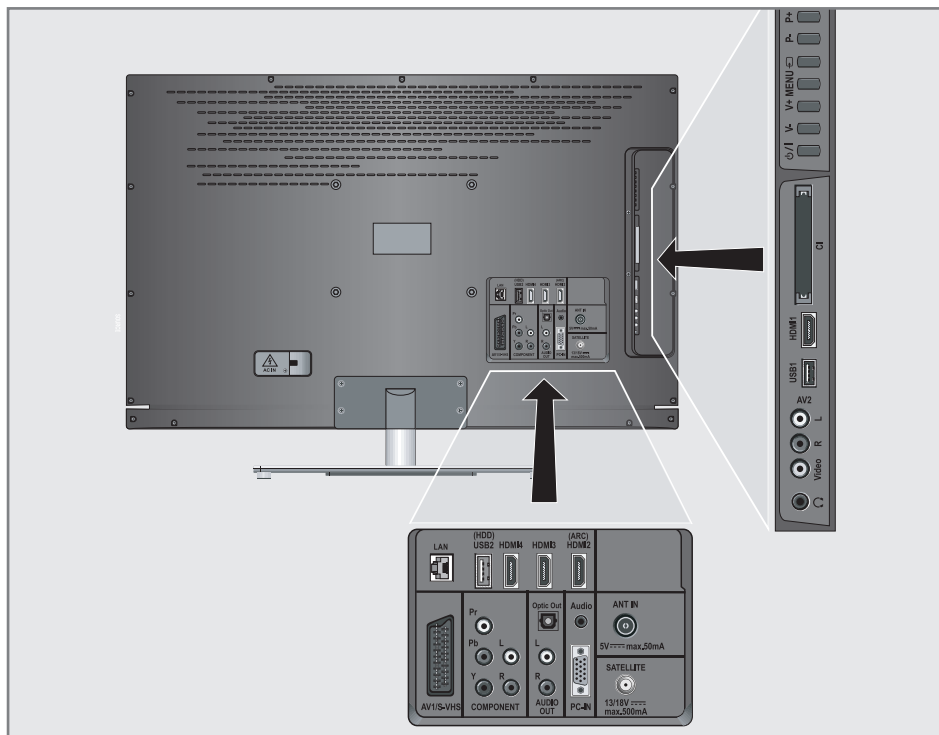

OPERATION USING EXTERNAL DEVICES

Connecting external devices

... with digital audio/video signals

- Suitable devices: Digital satellite receivers, Playstation, BluRay player, DVD player/recorder, set-top box, notebook, PCs.
- Video signal: Digital video; resolution: standard 576p; HDTV 720p, 1080i, 1080p.
- Audio signal: digital audio (stereo, multi-channel compression, uncompressed).
- Presets »HDMI 1«, »HDMI 2«, »HDMI 3« or »HDMI4«.

- 1 Connect the »HDMI1«, »HDMI2«, »HDMI3« or »HDMI4« socket on the television and the corresponding HDMI socket on the external device using a standard HDMI cable (digital video and audio signal).

... with analogue video signal (progressive)

- Suitable devices: DVD recorders/players, games consoles.
- Video signal: YUV; resolution: standard 576p; HDTV 720p, 1080i, 1080p.
- Audio signal: stereo, analogue.
- »Component« preset.

- 1 Connect the »COMPONENT Y Pb Pr« sockets on the television to the corresponding sockets of the external device with RCA cables (video signal).
- 2 Connect the »COMPONENT L R« sockets on the television to the corresponding sockets of the external device with RCA cables (audio signal).

... using the SCART socket (CVBS/RGB signal)

- Suitable devices: Digital satellite receiver, DVD player/recorder, set-top box, games console, video recorder, decoder.
- Video signal: CVBS/RGB.
- Audio signal: stereo, analogue.
- »AV1« preset.

- 1 Connect the »AV1/S-VHS« socket on the television and the corresponding socket on the external device using a SCART cable (video and audio signal).

Activating a decoder

If a decoder is connected to the »AV1/S-VHS« socket, this must be activated to provide an unencrypted video/audio signal.

- 1 Open the menu with »MENU«.
- 2 Select »SETTINGS« with »▼« or »▲« and press »OK« to confirm.
– The »SETTINGS« menu appears.
- 3 Select the »Decoder« with »▼« or »▲«.
- 4 Activate the function with »◀« or »▶« (»On«).
- 5 Press »MENU« to end the setting.

... with S-Video signal

- Suitable devices: DVD player/recorder, video recorder, camera recorder, notebook, PC.
- Video signal: Y/C.
- Audio signal: stereo, analogue.
- »S-VHS« preset.

- 1 Connect the »AV1/S-VHS« socket on the television and the corresponding socket on the external device using an EURO/AV cable (video and audio signal).

OPERATION USING EXTERNAL DEVICES

... with an analogue TV signal

- Suitable devices: Digital satellite receiver, DVD player/recorder, set-top box, camera recorder.
- Video signal: CVBS.
- Audio signal: stereo, analogue.
- »AV2« preset.

- 1 Connect the »Video« socket on the television to the corresponding socket of the external device with an RCA cable (video signal).
- 2 Connect the »L R« sockets on the television to the corresponding sockets of the external device with RCA cables (audio signal).

Note:

- There must not be a video signal at the »AV2« and »AV1/S-VHS« socket at the same time. This could lead to picture disturbances.

Using a DVD player, DVD recorder, video recorder or set-top box

- 1 Switch on the external device and select the function you wish to use.
- 2 Press  «, use »V«, »^«, »<« or »>« to select the preset for the input signal (»AV1«, »AV2«, »S-VHS«, »HDMI1«, »HDMI2«, »HDMI3«, »HDMI4« or »Component«) and press »OK« to confirm.

Headphones

Connecting the headphones

- 1 Plug the headphone jack (3.5 mm ø jack plug) into the headphone socket on the television.

Changing the headphone volume

- 1 Open the menu with »MENU«.
- 2 Select the menu item »SOUND SETTINGS« with »V« or »^« and press »OK« to confirm.
 - The »SOUND SETTINGS« menu appears.
- 4 Select the line »Headphone« with »V« or »^«.
- 5 Set the preferred volume with »<« and »>«.
- 6 Press »MENU« to end the setting.

Note:

- Prolonged listening with headphones at loud volumes can damage your hearing.

Hi-fi System

Connecting digital multi-channel amplifier/AV receiver

With this connection, you can playback the audio signal of the television channel via the HDMI cable sur the multi-channel amplifier or the AV receiver.

- 1 Connect the »HDMI2 (ARC)« (HDMI 1.4 Audio Return Channel) socket to the relevant socket on the HDMI ARC compliant Digital multichannel amplifier / AV receiver with a standard HDMI cable (digital audio signal);
or
- 2 Connect the »Optic Out« socket on the television to the corresponding socket on the AV receiver using a standard optic digital cable (digital audio signal).

Important:

- Do not use a HDMI cable longer than 5 m for HDMI ARC connection.

Apply the device with HDMI ARC function and activate HDMI ARC

- 1 Switch on the the multi-channel amplifier or the AV receiver. If a Blu-ray Player is connected on the AV receiver, the player must be switched on, too.
- 2 Open the Tools menu with »TOOLS« button.

OPERATION USING EXTERNAL DEVICES

- 3 Select the menu item »CEC« with »**V**« or »**▲**« and confirm with »**OK**«.
- The »HDMI CEC Device List« appears.
- 4 Start device search with »*« (red) button.
- Audio device connected to the »**HDMI2 (ARC)**« source shall be displayed in the list.

Notes:

- If the audio system also has a playing function (e.g. Home theater system, DVD player), two devices will be listed on the HDMI CEC list. The first one is the player, and the second one is the audio playback.
 - If a Blu-ray Player is connected to the AV receiver, please remove the Disc from the Player during the registration.
- 5 Press »**MENU**« button to exit the HDMI CEC device list.
 - 6 Open the menu with »**MENU**« button.
 - 7 Select the menu item »**SOUND SETTINGS**« with »**V**« or »**▲**« and confirm with »**OK**«.
- The menu appears.
 - 8 Select the line »Audio Output Setup« with »**V**« or »**▲**« and confirm with »**OK**«.
- The menu appears.
 - 9 Select the line »ARC« with »**V**« or »**▲**«.
 - 10 Select the setting »On« with »**◀**« or »**▶**«.

Notes:

- The internal speakers of the television are switching off automatically.
 - For switching off the HDMI ARC function select »Off« with »**◀**« or »**▶**«.
 - The ARC function will be deactivated while switching off the television and the internal speakers are active again.
- 11 Press »**MENU**« to end the setting.

Playing the audio signal via the HiFi system

- 1 Connect the »**AUDIO OUT L R**« sockets on the television to the corresponding socket of the AV receiver with an RCA cable (digital audio signal).

Note:

- If this function is not activated, the audio signal is transmitted to the HiFi system/AV receiver (connected to »**AUDIO OUT L R**«).

- 1 Open the menu with »**MENU**«.
- 2 Select the menu item »**SOUND SETTINGS**« with »**V**« or »**▲**« and press »**OK**« to confirm.
- The »**SOUND SETTINGS**« menu appears.
- 3 Select »Audio Output Setup« with »**V**« or »**▲**« and press »**OK**« to confirm.
- The menu appears.
- 4 Select the line »Audio Out« with »**V**« or »**▲**« and press »**◀**« or »**▶**« to activate the audio output (»Line Out«).
- 5 Select the line »Audio Out Status« with »**V**« or »**▲**« and select the option »Fixed« or »Adjustable« with »**◀**« or »**▶**«.

Notes:

- If you select »Adjustable«, the volume can be changed in the menu option »Audio Out Volume«.
 - If the audio should only be output via the HiFi system/AV receiver, select the option »Off« in the line »TV Speaker« with »**◀**« or »**▶**«.
- 6 Press »**MENU**« to end the setting.

“Dolby” and the double-D logo are trademarks of Dolby Laboratories.
Manufactured under licence from Dolby Laboratories.

OPERATION AS A PC MONITOR

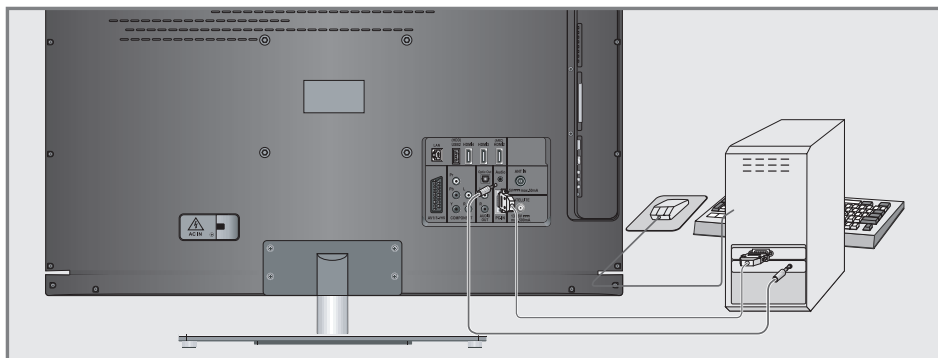

Connecting a PC

- 1 Connect the »PC-IN« socket on the television to the corresponding socket on the PC using a VGA cable (video signal).
- 2 Connect the »Audio« socket on the television to the corresponding socket on the PC using a suitable cable (audio signal).

Note:

- Adjust your PC to the monitor (for example, picture resolution 1280 x 768, picture frequency 60 Hz).

Selecting presets for the PC

- 1 Press »« and use »V«, »^«, »<« or »>« to select the preset »PC« and press »OK« to confirm.

Settings for PC mode

- 1 Open the menu with »MENU«.
- 2 Select the »SOURCE SETUP« menu item with »V« or »^« and press »OK« to confirm.
 - The »SOURCE SETUP« menu appears.
- 3 Select the function or setting with »V« or »^«, and then use »V«, »^« or »<«, »>« to implement it.

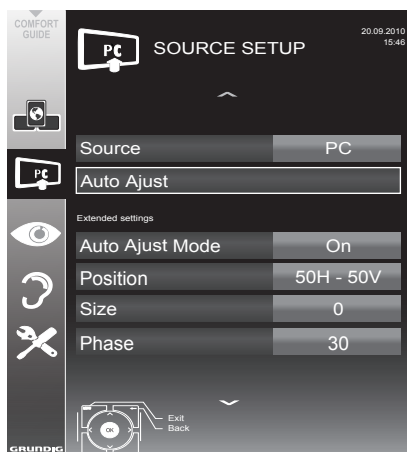

Options:

- »Auto Ajust« for automatic PC configuration.
- »Auto Ajust Mode«, select the option »On« if the configuration should be implemented automatically in PC mode.
- »Position« to configure the horizontal and vertical picture position.
- »Size« to set the cycle frequency.
- »Phase« to eliminate flicker, unfocused pictures or horizontal interference.

- 4 Press »MENU« to end the setting.

OPERATION WITH A COMMON INTERFACE

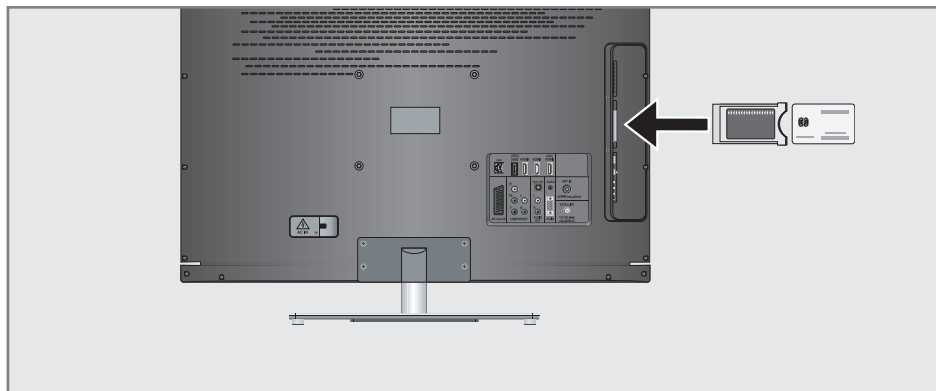

What is a Common Interface?

- Common Interface (CI) is an interface for DVB receivers.
- Encrypted channels can only be viewed with a CA module suitable for the encryption system and in conjunction with the corresponding smart card.
- The television set is equipped with a Common Interface slot into which CI modules from various providers can be inserted.
- You can insert the provider's smart card into the CA module in order to enable the encrypted channels you wish to view.

Inserting the CA module

Note:

- Switch the device off before you insert a CA module into the »CI« slot.
- 1 Insert the corresponding smart card into the CI module.
 - 2 Insert the CI module with the smart card into the »CI« slot on the television.

Note:

- In the »CA Module« sub-menu you can see which CA module has been inserted in the CI slot.
- If you are inserting a CA module into the CI slot of the television for the first time, you will need to wait a moment until the CA module is detected.

Access control for CI module and smart card

- 1 Open the menu with »MENU«.
- 2 Select the line »SOURCE SETUP« with »▼« or »▲« and press »OK« to confirm.
– The »SOURCE SETUP« menu appears.
- 3 Select the line »CA-Module« with »▼« or »▲« and press »OK« to confirm.

Notes:

- This menu provides operating instructions and – after you enter your PIN code – access to the PAY-TV provider's channels.
 - The remaining settings are described in the operating manuals for your CI module and smart card.
 - The CA modul is not supported in certain countries and regions; please consult your authorised dealer.
- 4 Press »MENU« to end the setting.

Searching for digital television channels from a satellite automatically

Satellite data changes frequently, new channels are constantly being added. You should therefore perform an automatic search from time to time.

This searches all transponders for new channels.

- 1 Open the menu with »MENU«.
- 2 Select the line »SOURCE SETUP« with »▼« or »▲« and press »OK« to confirm.
- The »SOURCE SETUP« menu appears.

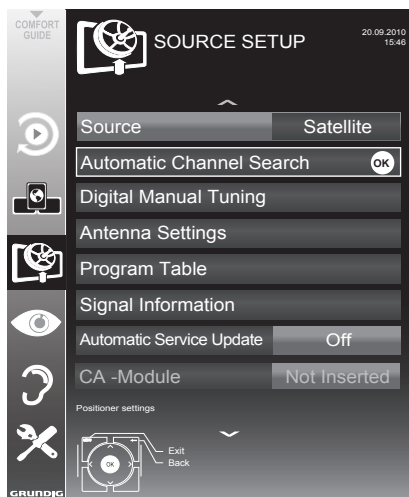

- 3 Select the line »Source« with »▼« or »▲« and press »OK« to confirm.
Select the input source »Satellite« with »◀«, »▶«, »▼« or »▲« and press »OK« to confirm.
- 4 Select the line »Automatic Channel Search« with »▼« or »▲« and press »OK« to confirm.
- The menu appears.
- 5 Select the line »Select Satellites« with »▼« or »▲« and press »OK« to confirm.
- The »SELECT SATELLITE« menu appears.
- 6 Select a satellite with »▼« or »▲« and press »OK« to confirm.

- 7 Select the line »Scan Mode« with »▼« or »▲«.
Select the scan mode with »◀« or »▶« (for unencrypted channels, for encrypted channels only, or both).
- 8 Select the line »Service Type« with »▼« or »▲«.
Use »◀« or »▶« to select whether you want to search for television channels (TV) only, radio stations only (Radio) or both (Radio + TV).
- 9 Select the line »Network Search« with »▼« or »▲«.
Select the option »On« with »◀« or »▶«
- If the »Network Search« is set to »On«, the data will be accessed via the new transponder of the network which has been set.
- 10 Start the scan with »••« (red).

Note:

- If the previously stored channels should be retained in the channel list and the new channels found be added to it, then press »••« (green).
If »••« (red) is pressed, the saved channels will be deleted from the current channel list.
- The »Results« menu appears, and the scan for TV channels begins.
- Depending on the number of television channels received, this can easily take a few minutes.
- The search is complete as soon as the »PROGRAM TABLE« appears.

Note:

- You can abort the search by pressing »MENU«.

- 11 Press »MENU« to end the setting.

SPECIAL SETTINGS

Searching for digital television channels from a satellite manually

If you know the parameters of a new television channel, you can also search for it manually. Current transponder data can be found in the teletext, in satellite TV magazines or on the Internet.

- 1 Open the menu with **»MENU«**.
- 2 Select the line **»SOURCE SETUP«** with **»▼«** or **»▲«** and press **»OK«** to confirm.
 - The **»SOURCE SETUP«** menu appears.
- 3 Select **»Digital Manual Tuning «** with **»▼«** or **»▲«** and press **»OK«** to confirm.
 - The menu appears.
- 4 Select the line required for the parameters with **»▼«** or **»▲«**.
 - **»Frequency (MHz)«**: Enter the five-digit frequency with **»1 ... 0«**.
 - **»Symbol Rate (kS/s)«**: Enter the five-digit symbol rate with **»1 ... 0«**.
 - **»Polarization«**: Use **»◀«** or **»▶«** to set the polarisation to **»Horizontal«** or **»Vertical«**.
 - **»Network Search«**: use **»◀«** or **»▶«** to select the option **»On«** or **»Off«**.
 - **»Scan Mode«**: Use **»◀«** or **»▶«** to select whether you want to search for unencrypted (Unencrypted) channels only, encrypted (Encrypted) channels only, or for both (Unencrypted + Encrypted).
 - **»Service Type«**: Use **»◀«** or **»▶«** to select whether you want to search for television channels only (TV), radio stations only (Radio), or both (Radio + TV).
- 5 Start the scan with **»*«** (red).
 - The **»Results«** menu appears, and the scan for TV channels begins.

Note:

- You can abort the search by pressing **»MENU«**.
- 6 Press **»MENU«** to end the setting.

LNB settings

Notes:

- The following description about the LNB settings premise a substantial expertise about the satellite systems. Ask your specialist dealer.

- Your TV supports SCR system (Satellite Channel Router). If you are using SCR satellite system, follow the steps described in **»LNB Type«** section.

- 1 Open the menu with **»MENU«**.
- 2 Select the line **»SOURCE SETUP«** with **»▼«** or **»▲«** and press **»OK«** to confirm.
 - The **»SOURCE SETUP«** menu appears.
- 3 Select **»Antenna Settings«** with **»▼«** or **»▲«** and press **»OK«** to confirm.
 - The **»ANTENNA SETTINGS«** menu appears.
- 4 Select the line required for the parameters with **»▼«** or **»▲«**.
 - **»Satellite«**: **»Press OK«**, select a satellite with **»◀«, »▶«, »▼«** or **»▲«** and press **»OK«** to confirm.
 - **»Transponder«**: **»Press OK«**, select a transponder with **»◀«, »▶«, »▼«** or **»▲«** and press **»OK«** to confirm. Use **»*«** (red) to add a transponder, use **»••«** (green) to delete it, or use **»•••«** (yellow) to change transponder data.
 - **»LNB Power«**: Set the LNB power supply (depending on the type of LNB) to **»Off«**, **»13/18 V«** or **»14/19 V«** with **»◀«** or **»▶«**.
 - **»LNB Type«**: Select the LNB type used in the satellite system with **»◀«** or **»▶«**. If you are using a satellite antenna with an Single Cable Distribution multiswitch, select the setting **»Grundig SCR«**. After it, please perform the **»User Band«, »KB Frequency«** and **»LNB Selection«** settings in the submenus. The necessary parameters you will get from the operator of the satellite antenna. Use only this specification!
 - »User Band«: Select the user band number assigned to the user with **»◀«** or **»▶«**.

»KB Frequency (MHz)«: Enter the user band frequency assigned to the user band with »1...0« buttons.

»LNB Selection«: If more than one satellites are used in the current SCR system, select »1/2« to »2/2« for the satellite corresponding to the relevant positions using »◀« or »▶« buttons.

Notes:

- Use installation equipment supported / suggested by your Multiswitch.
- Other users / receivers connected to the system may be affected if the specified user band number and frequency is changed during installation.
- User band and User band frequency is specified on the Multiswitch used; and each user / receiver uses a specified user band and user band frequency.
- With SCR satellite system, auto search by several users / receivers at the same time may cause problems.
 - »22 KHz«: Depending on the LNB type, 22 kHz audio is selected. For a universal LNB, this option is set to »Auto« and cannot be changed.
 - »DiSEqC mode« and »LNB selection«: depending on the type of antenna used, use »◀« or »▶« select the option »Off«, »DiSEqC 1.0« or »DiSEqC 1.1«.
 - »Off«: for a satellite system with only one antenna.
 - »DiSEqC 1.0«: allows up to four satellites to be received simultaneously. Under »LNB selection«, use »◀« or »▶« to select the option »1/4«, »2/4«, »3/4« or »4/4«.
 - »DiSEqC 1.1«: allows up to 16 satellites to be received simultaneously. Under »LNB selection«, use »◀« or »▶« to select the option »1/16« to »16/16«.

- 5 Press »MENU« to end the setting.

Settings for motorised antennas (DiSEqC 1.2)

Your television set supports motorised satellite systems in compliance with DiSEqC 1.2. This function allows the satellite antenna to be operated via the television set.

- 1 Open the menu with »MENU«.
- 2 Select the line »SOURCE SETUP« with »▼« or »▲« and press »OK« to confirm.
 - The »SOURCE SETUP« menu appears.
- 3 Select the line »DiSEqC 1.2« with »▼« or »▲«. Select the option »On« with »◀« or »▶«
 - The line »User Mode« is active.

Note:

- Additional operations are explained in the following sections.

SPECIAL SETTINGS

User mode

You can adjust the alignment of the satellite antenna to each individual satellite. These settings will be saved so that the antenna can later be easily guided to each saved alignment.

- 1 Select the line »User mode« with »V« or »^« and press »OK« to confirm.
 - The »USER MODE« menu appears.
- 2 Select the preferred option with »V« or »^«.
 - »Satellite«: »Press **OK**«, select a satellite with »<«, »>«, »V« or »^« and press »OK« to confirm.
 - »Transponder«: »Press **OK**«, select the transponder from which the signal is being received with »<«, »>«, »V« or »^« and press »OK« to confirm.
 - »Moving Mode«: Use »<« or »>« to select the option »Discrete« or »Continuous«.
 - »Discrete«: Moves the antenna in defined steps to the west and the east.
 - »Continuous«: Moves the antenna to the west or east continuously.
 - »Step Size«: Use »<« or »>« to select the number of steps with which the antenna should turn. »Step Size« is only active when the »Transport Mode« was set to »Discrete«.
 - »Move Motor«: Aligns the antenna with the selected satellite. Use »<« to align it to »West«, use »>« to align it to »East«.
 - »Go To Stored Position«: Aligns the antenna to a saved satellite position. Up to 50 positions can be saved. »Press **OK**« and then select the saved position with »<« or »>«. Press »•••« (green) to confirm - the antenna will be aligned with the saved position.
 - »Store Stored Position«: The current antenna alignment is saved.
- 3 Press »MENU« to end the setting.

Expert mode

You can restrict the antenna's range or reset the antenna.

- 1 Select the line »Installer Mode« with »V« or »^« and press »OK« to confirm.
 - The »INSTALLER MODE« menu appears.
- 2 Select the preferred option with »V« or »^«.
 - »Limit Position«: Defines the range in which the antenna may move. Use »<« to set the western limit, use »>« to set the eastern limit.
 - »Move Motor«: Aligns the antenna with the selected satellite. Use »<« to align the antenna to »west«, use »>« to align the antenna to »east«.
 - »Go To Stored Position«: Press »OK« to save the current antenna alignment.
 - »Store Stored Position«: Aligns the antenna with the reference point of the positioner.
 - »Reset DiSEqC 1.2 Limit«: Resets the limit position of the antenna.

Searching for television channels from the cable provider automatically

- 1 Open the menu with **»MENU«**.
- 2 Select the line **»SOURCE SETUP«** with **»V«** or **»^«** and press **»OK«** to confirm.
- The **»SOURCE SETUP«** menu appears.
- 3 Select the line **»Source«** with **»V«** or **»^«** and press **»OK«** to confirm.
Select the option **»Cable«** with **»<«, »>«, »V«** or **»^«** and press **»OK«** to confirm.
- 4 Select the line **»Automatic Channel Search«** with **»V«** or **»^«** and press **»OK«** to confirm.
- The menu appears.

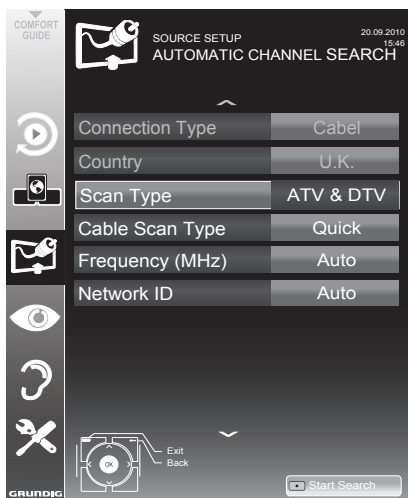

- 5 Select the line **»Scan Typ«** with **»V«** or **»^«** and set the option **»DTV«** with **»<«** or **»>«**.
- 6 Select the line **»Cable Scan Type«** with **»V«** or **»^«** and set the option **»Quick«** or **»Full«** with **»<«** or **»>«**.
- The search function **»Quick«** sets the channels according to the information provided by your cable provide in the transmission signal.
- If the option **»Full«** is selected, the entire frequency range will be scanned. The search can take a long time with this option. This option is recommended if your cable provider does not support the search type **»Quick«**.

Note:

- You can accelerate the search. To do this, you need information about the frequency and network ID. You are usually able to get this data from your cable operator or find it in forums on the Internet. For example, the frequency 402MHz and network ID 61441 can be entered for Germany.
- 7 Start the scan with **»••«** (red).
- All channel and favourites lists will be deleted and compiled anew.

Note:

- After starting the scan, a security query will appear. Press **»••«** (green) to confirm the option **»Yes«**.
- The **»Results«** menu appears, and the scan for TV channels begins. Depending on the number of television channels received, this can easily take a few minutes.
- The scan is complete as soon as the **»PROGRAM TABLE«** appears.

Note:

- You can abort the search by pressing **»MENU«**.
- 8 Press **»MENU«** to end the setting.

SPECIAL SETTINGS

Searching for television channels from the cable provider manually

- 1 Open the menu with »MENU«.
- 2 Select the line »SOURCE SETUP« with »▼« or »▲« and press »OK« to confirm.
- The »SOURCE SETUP« menu appears.
- 3 Select the line »Source« with »▼« or »▲« and press »OK« to confirm.
Select the option »Cable« with »◀«, »▶«, »▼« or »▲« and press »OK« to confirm.
- 4 Select »Digital Manual Tuning« with »▼« or »▲« and press »OK« to confirm.
- The menu appears.
- 5 Enter the four-digit frequency with »1 ... 0« and press »OK« to confirm.
- The search starts after confirming, the channels found are displayed in the »Results« menu.
- 6 Press »MENU« to finish the setting.

Searching for digital terrestrial TV channels automatically

- 1 Open the menu with »MENU«.
- 2 Select the line »SOURCE SETUP« with »▼« or »▲« and press »OK« to confirm.
- The »SOURCE SETUP« menu appears.
- 3 Select the line »Source« with »▼« or »▲« and press »OK« to confirm.
Select the option »Air« with »◀«, »▶«, »▼« or »▲« and press »OK« to confirm.

Caution:

- The antenna power supply (line »Active Antenna Power«) may only be switched on if the antenna is an active indoor antenna with a signal amplifier and it is not already supplied with a voltage via a mains plug (or similar supply). Otherwise you may cause a short circuit and irreparably damage your antenna.
- 4 Select the »Active Antenna Power« with »▼« or »▲«. Switch on the antenna power supply for the antenna with »◀« or »▶« (»On«).
 - 5 Select the line »Automatic Channel Search« with »▼« or »▲« and press »OK« to confirm.
- The menu appears.

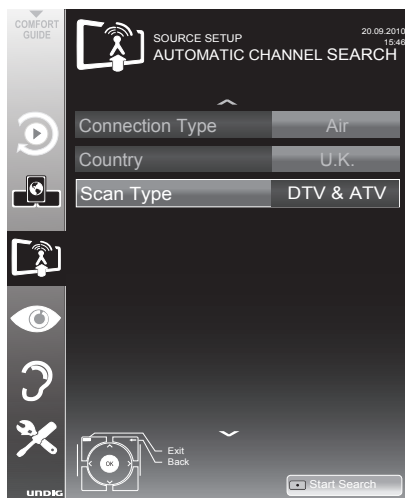

SPECIAL SETTINGS

- 6 Select the line »Scan Typ« with »V« or »^« and set the option »DTV« with »<« or »>«.
- 7 Start the scan with »*« (red).
 - All channel and favourites lists will be deleted and compiled anew.

Note:

- After starting the scan, a security query will appear. Press »**« (green) to confirm the option »Yes«.
- The »Reults« menu appears, and the scan for TV channels begins. Depending on the number of television channels received, this can easily take a few minutes.
- The scan is complete as soon as the »PROGRAM TABLE« appears.

Note:

- You can abort the search by pressing »MENU«.

- 8 Press »MENU« to end the setting.

Automatic service update

If this function is activated, possible changes of network operators are updated automatically.

The unit must be located in stand-by mode.

- 1 Open the menu with »MENU«.
- 2 Select the line »SOURCE SETUP« with »V« or »^« and press »OK« to confirm.
- 3 Select the line »Automatic Service Update« with »V« or »^«.
- 4 Select the automatic update with »<« or »>« (»On«).
- 5 Press »MENU« to end setting.

Searching for digital terrestrial TV channels manually

- 1 Open the menu with »MENU«.
- 2 Select the line »SOURCE SETUP« with »V« or »^« and press »OK« to confirm.
 - The »SOURCE SETUP« menu appears.
- 3 Select the line »Source« with »V« or »^« and press »OK« to confirm.
Select the option »Air« with »<«, »>«, »V« or »^« and press »OK« to confirm.

Caution:

- The antenna power supply (line »Active Antenna Power«) may only be switched on if the antenna is an active indoor antenna with a signal amplifier and it is not already supplied with a voltage via a mains plug (or similar supply). Otherwise you may cause a short circuit and irreparably damage your antenna.
- 4 Select the »Active Antenna Power« with »V« or »^«. Switch on the antenna power supply for the antenna with »<« or »>« (»On«).
 - 5 Select » Digital Manual Tuning« with »V« or »^« and press »OK« to confirm.
 - The menu appears.
 - 6 Enter the channel number directly with »1 ... 0« and press »OK« to confirm.
 - After the search is complete, the channels found are displayed in the »Results« menu.
 - 7 Press »MENU« to finish the setting.

Tuning analogue television channels

This setting is only necessary if you cannot receive any digital channels and you have not carried out an analogue search during initial setup. The television channels can be set directly or using the scan.

Switching the television to analogue reception

Note:

- Analogue channels can be selected if the option »Air« or »Cable« has been selected.

- 1 Open the »Select input source« menu with »**→**«.
- 2 Depending on the antenna system, select the option »Air« or »Cable« with »**▼**«, »**▲**«, »**◀**« or »**▶**« as the input source and press »**OK**« to confirm.

Note:

- Additional operations are explained in the following sections.

Setting all analogue television channels

Analogue channels are displayed in the channel list after the digital channels.

Note:

- Plug the rooftop antenna cable (for analogue television channels) into the »**ANT IN**« socket on the television.

- 1 Open the menu with »**MENU**«.
- 2 Select the line »SOURCE SETUP« with »**▼**« or »**▲**« and press »**OK**« to confirm.
 - The »SOURCE SETUP« menu appears.
- 3 Select the line »Source« with »**▼**« or »**▲**« and press »**OK**« to confirm. Select the option »Air« or »Cable« with »**◀**«, »**▶**«, »**▼**« or »**▲**« and press »**OK**« to confirm.

- 4 Select the line »Automatic Channel Search« with »**▼**« or »**▲**« and press »**OK**« to confirm.



- 5 Select the line »Scan Typ« with »**▼**« or »**▲**« and set the option »ATV« with »**◀**« or »**▶**«.
- 6 Start the scan with »••« (red).

Note:

- After starting the scan, a security query will appear. Press »••« (green) to confirm the option »Yes«.
 - All channel and favourites lists for the analogue channels will be deleted and compiled anew.
 - The »Results« menu appears, and the scan for TV channels begins. Depending on the number of television channels received, this can easily take a few minutes.
 - The search is complete as soon as the »PROGRAM TABLE« appears.

Note:

- You can abort the search by pressing »**MENU**«.

- 7 Press »**MENU**« to end the setting.

SPECIAL SETTINGS

Tuning the television channels by entering the channel numbers

- 1 Open the menu with »MENU«.
- 2 Select the line »SOURCE SETUP« with »V« or »^« and press »OK« to confirm.
– The »SOURCE SETUP« menu appears.
- 3 Select the line » Analogue Manual Tuning« with »V« or »^« and press »OK« to confirm.
– The menu appears.

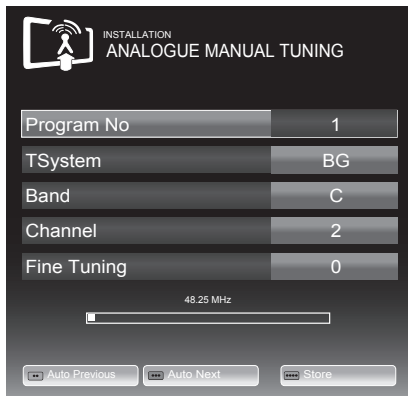

- 4 Select the line »Program No« by pressing »V« or »^« and use »<« or »>« to save the preset.
- 5 Select »Band« by pressing »V« or »^« and use »<« or »>« to choose between »S« (special channel) or »C« (normal channel).
- 6 Select the line »Channel« with »V« or »^« and enter the channel number with »<« or »>« step by step, or use »1...0« to enter the channel number directly, or start a automatic scan with »..« (green) oder »...« (yellow).

Notes:

- The current system is displayed in the »System« line. If the colour or sound is not functioning properly, select the line »System« with »V« or »^«. Use »<« or »>« to select the preferred setting.
 - If fine tuning is necessary, select the line »Fine Tuning« with »V« or »^« and use »<« or »>« to make the setting.
- 7 Press »...« (blue) to save the setting.

Note:

- If you wish to remedy other television channels, repeat steps 4 to 7.
- 8 Press »MENU« to end the setting.

Changing stored analogue channels

If channels were stored with the automatic channel search while tuning the television channels, you can delete them. You can also store channels in a different preset, change or enter the name of a channel as well as skip channels.

Selecting a channel list

- 1 Open the menu with »MENU«.
- 2 Select the line »SOURCE SETUP« with »V« or »^« and press »OK« to confirm.
– The »SOURCE SETUP« menu appears.
- 3 Select the line »Program Table« with »V« or »^« and press »OK« to confirm.
– The »PROGRAME TABLE« menu appears.

Note:

- Additional operations are explained in the following sections.

Deleting channels

- 1 In the »PROGRAME TABLE« menu, select the television channel to be deleted with »V«, »^«, »<« or »>« and press »*« (red) to confirm.
- 2 Delete the selected channel by pressing »...« (yellow).

Note:

- »...« (blue) allows all television channels to be deleted.
- 3 Press »...« (green) to confirm the deletion process.

SPECIAL SETTINGS

Entering channel names (8 digit maximum)

- 1 In the »PROGRAMME TABLE« menu, select the television channel with »V«, »^«, »<« or »>« and press »*« (red) to confirm.
- 2 Open the input keyboard with »*« (green).

Note:

- If necessary, delete the current channel name. To do this, select the »x« button with »<« or »>« and delete repeatedly using »OK«.
- 3 Select the required letters or numbers with »V«, »^«, »<« or »>« and confirm with »OK«.
Repeat the entry for further letters/numbers.

Note:

- Use the »ABC« button to switch to upper case letters and use the »?@123« button to switch to symbols and numbers.
- 4 Save the channel name by using »V«, »^«, »<« or »>« to select »Submit« and confirm with »OK«.

Note:

- If you wish to enter other channel names, repeat steps 1 to 4.

Skipping television channels

You can highlight television channels to be skipped when you select with »^« or »V«. Selection is still possible using the number buttons.

- 1 In the »PROGRAMME TABLE« menu, switch over to the list view with »*« (yellow).
- 2 Select the preferred channel with »V« or »^«.
- 3 Select the column »Skip« with »<« or »>« and use »OK« to mark the channel.
 - The channel is marked using »✓«.

Note:

- Channels can also be reactivated. Select the channel with »V« or »^«, then select the column »Skip« and reactivate the channel with »OK«.

Creating lists of favourites

You can select your favourite channels and save them in up to four favourites lists (Fav 1 to Fav 4).

- 1 In the »PROGRAMME TABLE« menu, switch over to the list view with »*« (yellow).
- 2 Select the preferred channel with »V« or »^«.
- 3 Use »<« or »>« to "push" the channel into one of the favourites lists 1 to 4 and press »OK« to confirm.
 - The position in the favourites list is marked with »✓«.
 - You can enter the same channel in more than one favourite list.
 - Each favourite list can store up to 255 channels.

Note:

- Channels can also be deleted from favourites lists. Select the channel to be deleted with »V«, »^«, »<« or »>« and delete it with »OK«.

Exiting the settings

- 1 Press »MENU« to end the setting.

Displaying signal information

(for digital channels only)

- 1 Open the menu with »**MENU**«.
- 2 Select the line »SOURCE SETUP« with »**V**« or »**^**« and press »**OK**« to confirm.
- 3 Select the line »Signal Information« with »**V**« or »**^**« and press »**OK**« to confirm.
 - Information on the channel, network, modulation, symbol rate, quality and signal strength is displayed.

Notes:

- The signal information changes in accordance with the current input source.
 - The signal properties are displayed in the lower section of the menu. The further the bars for »Quality« and »Signal Strength« extend to the right, the better the reception signal.
 - The signal level not only depends on your receiver system, but also on the channel which is currently active. Remember this when aligning your antenna based upon the signal level display.
- 4 Press »**MENU**« to close the menu.

INFORMATION

GRUNDIG 40 VLE 812 S

Technical data

Operating voltage:

220-240 V,~, 50-60 Hz

Power consumption:

On mode 63 W
Standby <0.50 W

Energy Efficiency class:

A

Maximum power consumption

On mode 145 W

Annual power consumption

92 kWh

Audio output:

2 x 20 W music power output
2 x 10 W Sine wave power

Rohs Limits: Pb (Lead)/Hg (Mercury)

Pb meets ROHS directive / 0 mg

Peak luminance ratio:

65 %

Default satellite:

20

LNB power supply:

13/18 V, 14/19 V optional, maximum 450 mA

LNB switching signal:

0/22 kHz 650mV +/- 250mVpp

DiSEqC:

1.0-operation, 1.1-operation, 1.2-operation

Digital reception ranges

Satellite:

Ku band: 10,700 MHz - 12,750 MHz
Modulation: DVBS QPSK, DVBS2 QPSK,
8 PSK
IF band: 950 MHz - 2,150 MHz
Signal level: -25dBm to -65 dBm

Cable:

Overall band: 110 MHz - 862 MHz
Modulation: 16QAM, 32QAM, 64QAM,
128QAM and 256QAM
Symbol rate: 4.0 Msym/s to 7.4 Msym/s

Terrestrial (DVB-T):

VHF/UHF band, Bandwidth 7 MHz
and 8 MHz
FFT Size: 2k, 8k
Modulation: 16QAM, 64QAM, QPSK
Guard Interval: 1/4, 1/8, 1/16, 1/32

Terrestrial (DVB-T2):

VHF/UHF band, Bandwidth 7 MHz
and 8 MHz
FFT Size: 1k, 2k, 4k, 8k, 16k, 32k
Modulation: 16QAM, 64QAM,
256QAM, QPSK
Guard Interval: 1/4, 19/256, 1/8, 19/128,
1/16, 1/32, 1/128

As this feature is optional, it is not available in all products.

Analogue reception ranges:

C02 ... C80, special channels S01 ... S41

Preset channels:

All Channels 6000 (Satellite - DVB-S),
1000 (Cable - DVB-C) or
99 (Analogue)
1000 (Terrestrial - DVB-T) or
99 (Analogue)
9 AV, 2 USB

Screen (dm²):

44 dm²

Screen size:

102 cm/40 inch

Maximum resolution:

WUXGA, 1920 x 1080

Weight:

approx. 18 kg

Dimensions:

W H D 92 cm x 63,7 cm x 4,3 cm

Technical changes and errors reserved.

Service information for dealers



Only operate the television with the power supply/power cord provided.

The product complies with the following EU directives:

Power consumption values and classes are specified according to the regulations 2009/642 and 2010/1062 and the standards EN62087 and EN62301 as per European Union framework directives 2009/125/EC and 2010/30/EU.

With this note, Grundig declares that this appliance is in conformity with the main and other relevant terms of the 1999/5/EC directive.

To obtain a copy of the Declaration of Conformity (Doc), please submit your request by using the contact information at www.grundig.com/download/doc

This appliance can be operated in the following European countries.

AT	BE	BG	CH	CY	CZ	DE	DK
EE	ES	FI	FR	GB	GR	HU	IE
IS	IT	LI	LT	LU	LV	MT	NL
NO	PL	PT	RO	SE	SI	SK	TR

This appliance can also be operated in countries outside Europe.

Please observance the restrictions for the following countries:

For customers in France

Outdoor use limited to 10 mW e.i.r.p. within the band 2454-2483.5 MHz. Military Radiolocation use. Refarming of the 2.4 GHz has been ongoing in recent years to allow current relaxed regulation. Full implementation planned 2012.

For customers in Italy

For private use, a general authorisation is required if WAS/RLAN's are used outside own premises. For public use, a general authorisation is required.

For customers in Norway

This subsection does not apply for the geographical area within a radius of 20 km from the centre of Ny-Ålesund.

For customers in Russian

1. SRD with FHSS modulation

- Maximum 2.5 mW e.i.r.p.
- Maximum 100 mW e.i.r.p. Permitted for use SRD for outdoor applications without restriction on installation height only for purposes of gathering telemetry information for automated monitoring and resources accounting systems. Permitted to use SRD for other purposes for outdoor applications only when the installation height is not exceeding 10 m above the ground surface.
- Maximum 100 mW e.i.r.p. Indoor applications.

2. SRD with DSSS and other than FHSS wideband modulation

- Maximum mean e.i.r.p. density is 2 mW/MHz. Maximum 100 mW e.i.r.p.
- Maximum mean e.i.r.p. density is 20 mW/MHz. Maximum 100 mW e.i.r.p. Permitted to use SRD for outdoor applications only for purposes of gathering telemetry information for automated monitoring and resources accounting systems or security systems.
- Maximum mean e.i.r.p. density is 10 mW/MHz. Maximum 100 mW e.i.r.p. Indoor applications.

For customers in Ukraine

e.i.r.p. ≤ 100 mW with built-in antenna with amplification factor up to 6 dBi.

Environmental note



This product has been made from high-quality parts and materials which can be re-used and recycled.

Therefore, do not dispose of the product along with normal household waste at the end of its service life. Take it to a collection point for the recycling of electrical and electronic equipment. Dispose of the used device at a collection point for electrical and electronic equipment. The symbol on the product, in the operating manual or on the packaging indicates that recycling is possible. Information on collection points is available from your local authorities.

Help protect the environment by recycling used products.

INFORMATION

Troubleshooting

If the information provided below does not help, please consult an authorised GRUNDIG dealer. Please bear in mind that malfunctions can also be caused by external devices such as video recorders or satellite receivers.

Problem	Possible cause	Remedy
Screen lit (snow), but no station visible	Antenna cable	Is the antenna cable connected?
	No TV channel tuned	Start a channel scan
Insufficient contrast in picture	The picture settings are not correct	Adjust the brightness, contrast or colour setting
	Problem at station	Try another channel
Picture and/or sound distorted	Interference from other devices	Place the device in a different position
Ghosting, reflection	Channel setting	Automatic or manual tuning/fine tuning
	Antenna	Have antenna cable or system checked
No colour	Colour intensity too low	Turn up the colour
	Adjust TV standard (if setting option is available)	Select the correct colour standard
Picture but no sound	Problem at station	Try a different channel
	Volume is set to a minimum	Turn up or switch on the volume
Teletext impaired or absent	Problem at station	Try a different channel
	Television channel (no teletext) or antenna system	Try with a different TV channel, carry out fine tuning
	Station signal too weak	Check antenna
The remote control does not work	Obstacle between remote control and device.	Point remote control at television
	Battery problem	Check batteries and replace if necessary
	Operating mode undefined	Switch off the television at the mains switch for two minutes
Picture too dark in PC mode	Incorrect setting for picture resolution and picture frequency on the PC	Change settings on the PC (e.g. 1280 x 768 resolution, refresh rate 60 Hz)
DMS device cannot be found	DMS device is not switched on or not started	Make sure that the DMS device is on and operating.
	Network connection settings are not made.	Check the network settings.

INFORMATION

Problem	Possible cause	Remedy
Low image quality (pixel) in WLAN mode	Signal is lost based on structural conditions.	Place the modem so that the signal to the television is not interrupted.
	Internet connection speed low.	Low Internet speed is a problem that is related with the speed of your subscription or a failure in the Internet infrastructure. Contact with your service provided (ISP).
	DMS (for example PC) is connected to the wireless network and away from the modem	Bring your DMS closer to the modem
Warnings about the connection problems on the display	Network Cable or wireless USB network device may be disconnected	Check network cable or wireless USB network device
	Modem does not have Internet connection or has problems	Make sure that your modem has Internet connection
Videos in video applications are lagging during playback in wired connection	Internet connection speed low	Low Internet speed is a problem that is related with the speed of your subscription or a failure in the Internet infrastructure. Contact with your service provided (ISP).
There are connection problems in inter@ctive applications	This may occur due to temporary problems in servers of these applications	Try connecting to the applications again

Note:

- This is a Class A product. During operation the device can cause radio interference. In this case the user may have to remedy this. Please contact your specialist dealer.